

peerless-AV[®]

Driving Technology Through Innovation



Professional AV Mounts and Solutions

peerless-AV

Investing in our Planet

Our Commitment to Environmental Sustainability

Protecting the world's environment is a crucial concern for everyone. At Peerless-AV®, we are committed to playing a role in reducing the world's and our own carbon footprint, implementing environmentally conscious practices as a company, and providing a safe workplace for all our employees. We make it a necessity to develop and manufacture our mounting solutions sustainably to ensure we are doing our part.



ISO 9001
certified since
1997



ISO 14001:2015
certified since
2020

Environmental Objectives

Achieve 90% landfill waste diversion year-on-year & 100% meet Compliance Obligations

2025 Objectives

Paintline AC Unit replacement & implementation of Compressed Air Leak detection program with est. savings: 32,800 kWh / year, which equates to 13 Tons of GHG emissions

Environmental Management System

Pollution Prevention

Carbon Reduction

Compliance Obligations

Green Initiatives

20%< Electricity used that reduced GHG Scope 2 Emissions by 25%

21%< Waste landfilled that reduced GHG Scope 3 emissions by 19%

77,073,924 smartphones charged

2,427,720 miles driven by an average petrol vehicle

15,763 tree seedlings grown for 10 years

ISO 14001:2015 certification achieved in 2020 at the Aurora, IL Global Headquarters and Manufacturing Facility. *Aurora, US, only. These numbers are updated annually.

SEAMLESS dvLED MOUNTING SOLUTIONS

SEAMLESS Overview	12-13
SEAMLESS Connect Universal	14-15
SEAMLESS Connect Substructures	16-17
SEAMLESS Universal Trim Kit	18
SEAMLESS Kitted for LG and Samsung	19
SEAMLESS Connect All-in-One	20-21
SEAMLESS Bespoke Series	22-23

DIGITAL SIGNAGE MOUNTS

Video Wall Mount Features & Benefits	24
Supreme Video Wall Mount	25
Full Service & Quick Release Video Wall Mounts	26
Large Format & Ultra-Slim Video Wall Mounts	27
Flat Video Wall Mounts	28
Video Wall Trolleys & Stands	29
Menu Board Mounts	30
Retail Display Mounts	31
Column and I-Beam Mounts	32
Media Player Holders	33

FLAT PANEL WALL MOUNTS

Ultra Slim™	34-35
SmartMount®	36-37
Paramount™	38-39

SPECIALITY WALL MOUNTS

Universal Scissor Wall Mount	40
Lockable Wall Mounts	41
Speciality Mounts and In-Wall Boxes	42

ACCESSORIES

Adaptor Plates and AV Accessories	43
Soundbar Mounts	43

TROLLEYS & STANDS

SmartMount® Flat Panel Trolleys	44-46
Motorised Trolleys	47
Mobile Trolleys for the Samsung Flip and Microsoft® Surface™ Hub 2S/2X	48
Floor Stands and Accessories	49

MODULAR SERIES

Twin Pole Modular Series Overview	50-51
Twin Pole - Single Unit Applications	52-53
Twin Pole - Video Wall Applications	54-55
Single Pole Modular Series	56-57

XTREME™ OUTDOOR DISPLAY

Xtreme™ Overview & Features	58-59
Xtreme™ 55" Specifications	61
Xtreme™ 75" Specifications	60

OUTDOOR KIOSKS & ENCLOSURES

Outdoor Xtreme™ Smart City Kiosk	62-63
Xtreme™ IR Touch Overlay	63
Outdoor Digital Signage Boards	64
Outdoor Mounts	65

KIOSK RANGE

Portrait Totem Kiosks	66-67
Landscape Kiosks	68
Custom Finish Options	69

PROJECTOR MOUNTS

Single Pole Modular Kits	70-71
Heavy Duty Projector Mounts	72
Projector Mounts	73

MONITOR & TABLET MOUNTS

Freestanding Desktop Stand	74
Desktop, Wall and Tablet Mounts	75

FLAT PANEL CEILING MOUNTS

Ceiling Mounts for Multiple Displays	76
Ceiling Mounts for LCD screens	77

PRO CEILING KITS

Ceiling Mount Projector & Flat Panel System	78
---	----

peerless-AV[®]

Driving Technology Through Innovation

As a global leader in audio visual innovation for over 80 years, we pride ourselves on delivering award-winning products and services that exceed your needs, whether they are large or small. Peerless-AV[®] was built on a strong foundation and we continue to thrive because of you, our loyal customer. Thank you for your business. We look forward to collaborating with you for the years to come!



GLOBAL ORGANISATION



OUR PROFILE

Peerless-AV[®] is a leading designer, manufacturer and distributor of AV solutions, including award-winning fully sealed outdoor displays/TVs, indoor/outdoor kiosks, dvLED and LCD mounting systems.



OUR MISSION

We will meet and strive to exceed our customers' expectation for quality products and services. We will do our best to make it easy and pleasant to do business with us.



OUR VISION

We aspire to industry dominance through providing our customers with standard-setting product quality, service and value.

Check out our online resources at [peerless-av.com](https://www.peerless-av.com)

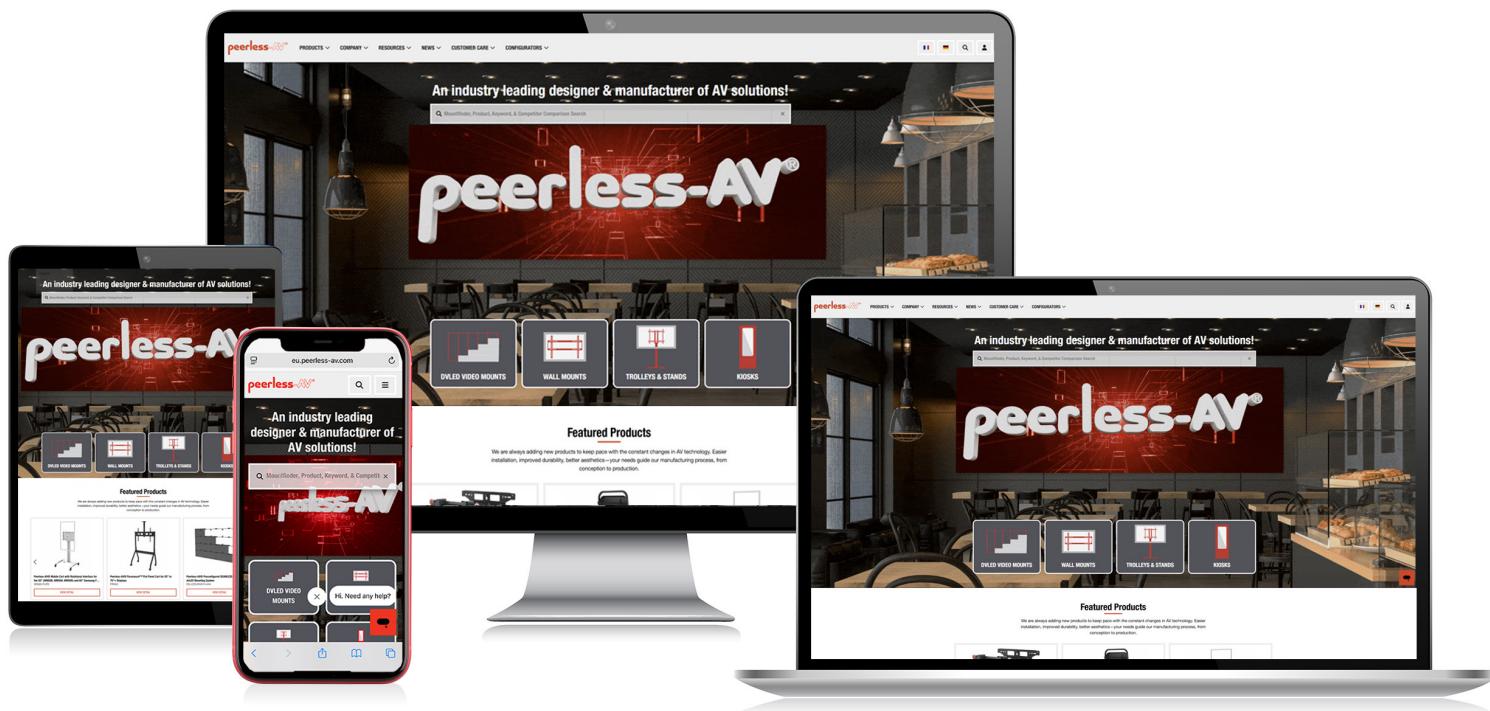

MountFinder™ | dvLED Video Wall Configurator | Modular Mount Configurator | Revit Files

**WE'RE SOCIAL –
INTERACT WITH US
ON YOUR FAVOURITE SOCIAL MEDIA SITE!**

**STAY
CONNECTED**

Social media has played an important part in helping build Peerless-AV's relationships online. We believe social networks give us a platform to show not only what we sell, but to express who we are as a company. That's why you'll see pictures of the team having fun in the office posted alongside our latest product press release. We are real and authentic with our followers because we want you interested, engaged and connected with us at all times.



FOLLOW US

LinkedIn | Vimeo | Instagram | X
@Peerless-AV EMEA | @PeerlessAVEU



TROLLEYS AND STANDS

Peerless-AV's sleek and stylish trolleys and stands are designed to provide the ideal display viewing position and match the décor of any environment - boardrooms, training rooms, lobbies, classrooms, auditoriums or exhibition halls. A full line-up of accessories allows each stand to be tailored to meet specific requirements - whether video conferencing in a boardroom or presenting on a trade show floor.

See page 44 for more details

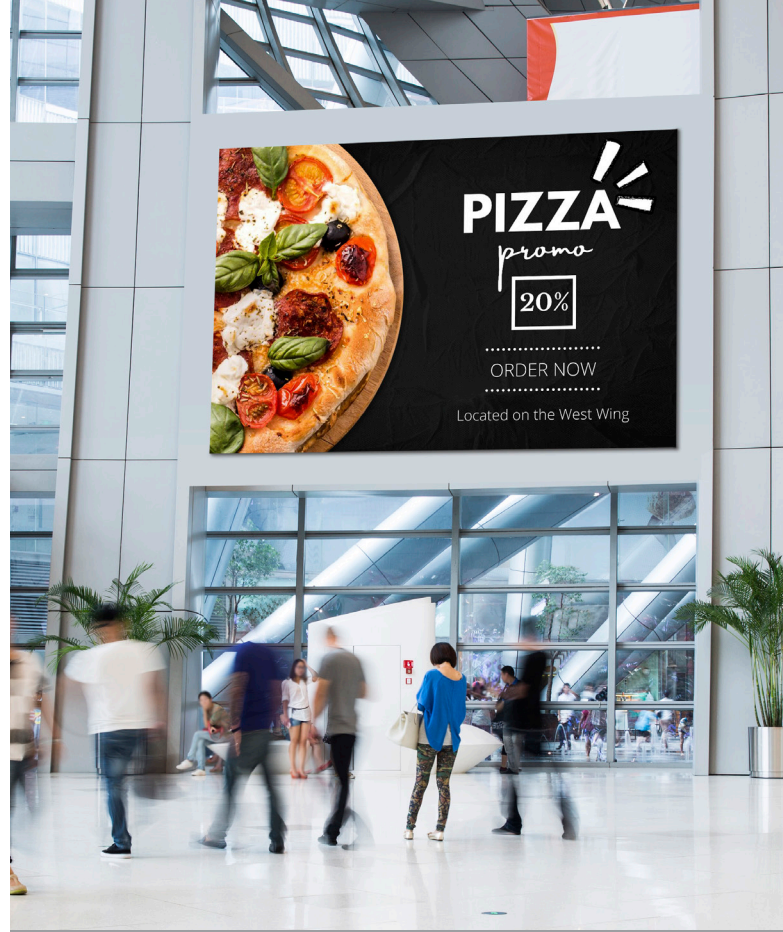

dvLED MOUNTING SOLUTIONS

With over 85 years of audio visual experience, our commitment to the creation of cutting-edge technology and standard-setting solutions has elevated us to the status of the industry's most innovative leader. Our Dedicated SEAMLESS dvLED Solutions Team sets the bar for high quality design, while achieving the pinnacle of aesthetic results. The entire Peerless-AV® dvLED Solutions Team is there every step of the way to ensure every customer receives SEAMLESS product support and service.

See page 12 for more details

PEERLESS-AV COMPANY HISTORY & PRODUCT MILESTONES

Designed and developed
the first known CRT
TV wall mount

1965



1941

Peerless opened
its doors for
business

Plasma, LCD, and
projector mounts are
introduced

2003



2009

Opened
EMEA office
& warehouse

Launched
Video wall
mounts

2010



2012

Developed range
of portrait &
landscape kiosks

Released
Fully Sealed
Outdoor Displays

2013





KIOSK RANGE

Choose from a versatile array of sleek, slim and attractive standard kiosk enclosures or create a completely unique kiosk solution fit for any application and market - corporate, education, quick serve restaurants, hospitality, stadiums, retail and more. Our kiosks are customisable in every way - from the size and specifications to custom paint and vinyl wraps. If you can envision it, we can make it happen.

See page 62 for more details



OUTDOOR DISPLAYS

Our all-weather outdoor display has proved itself in highly successful, exemplary installations across EMEA in museums, visitor attractions, corporate offices, ski resorts, electric vehicle charging stations, custom outdoor wayfinding kiosks and more. The Xtreme™ High Bright provides up to 3,000nits of light output, with an IP66 and IK10 rating, and the widest operating temperature range to perform beyond customer expectations, all year round, opening new and exciting opportunities for Digital Signage.

See page 58 for more details

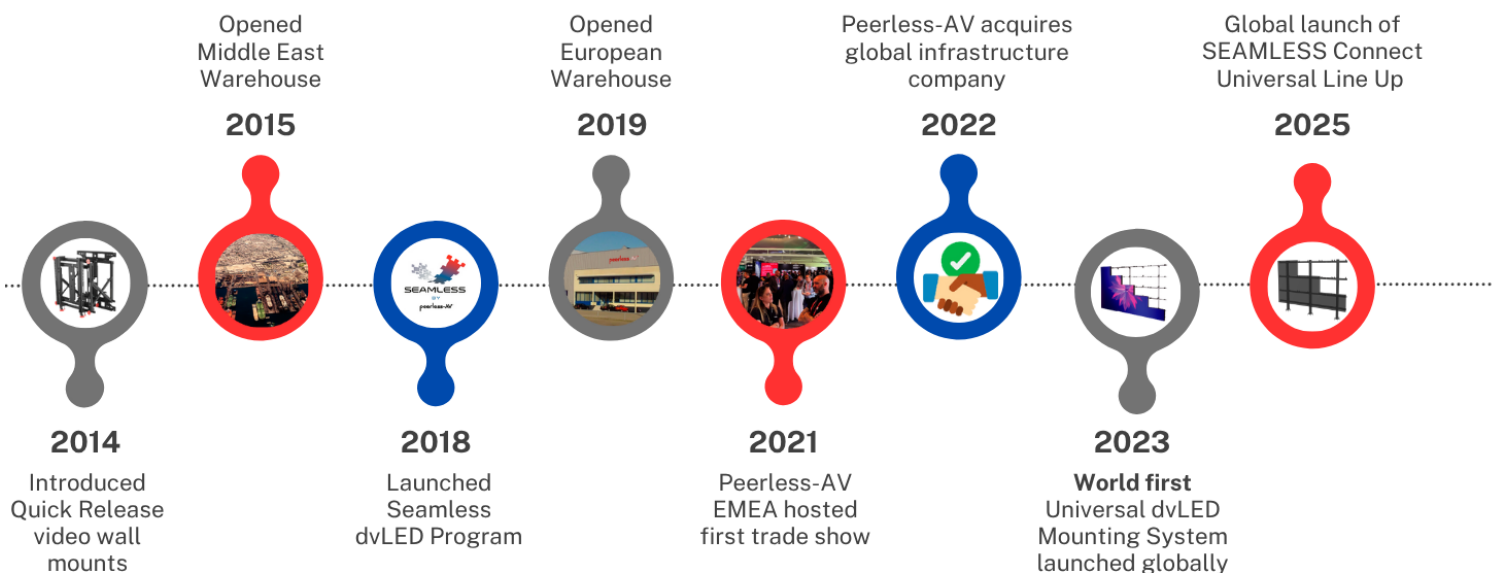

Peerless-AV Case Studies

Projects Around The Globe

LARGEST IMMERSIVE VIDEO WALL IN NORTH AFRICA

📍 MOROCCO, NORTH AFRICA

The mammoth concave curved dvLED video wall, located in the auditorium of Mohammed VI Polytechnic University in Morocco, consists of 183 x 5 Samsung IFH-E LED cabinets in 2.5 pixel pitch, supported by a SEAMLESS Bespoke curved dvLED Mounting System. It spans 87.84m x 2.70m, within a fully floating cylinder measuring 32 metres in diameter and with a radius of 313.46°. A total 915 Samsung cabinets, 5490 modules and 37,946,880 pixels make this a milestone project in the history of Moroccan, and even African architecture. Thanks to our partners Cegelec Morocco, Atrait Consulting and Samsung France for making this such a huge success. This is one of our ultimate showcases in which we are unbelievably proud to be an integral partner, providing start to finish project support, including design, consultation, engineering, manufacturing, testing, on-site training and installation, commissioning and sign off.



THE NATIONAL GALLERY

📍 LONDON, UNITED KINGDOM

As part of its 200th anniversary celebrations, The National Gallery in Trafalgar Square, London, set out to create an immersive and intuitive visitor experience around one of the world's most prestigious art institutions. The centrepiece of the foyer of the historic Sainsbury Wing, is a Samsung The Wall (IWoo8C) ultra-wide video wall in a 13x6 configuration (78 cabinets), measuring 10.5m by 2.7m with 0.8mm pixel pitch 16K MicroLED displays. The Wall is supported by a SEAMLESS Bespoke floor-to-wall structure by Peerless-AV, engineered specifically for a space where no physical wall existed, housed within a custom mahogany timber frame, with integrated Samsung subwoofers, ventilation and concealed cable access. Around the venue Peerless-AV also delivered custom solutions for two 2x6 LED pillar columns in the foyer, outdoor kiosks at the entrance and totems in the main foyer, plus numerous mounts in event spaces, lift lobbies, cloakroom and transition areas.

THE
NATIONAL
GALLERY



View and download all of our in-depth Case Studies via the website (www.peerless-av.com) to learn more about Peerless-AV installations in a number of different market sectors and a variety of locations.

BLINDERS SPORTS LOUNGE 📍 CHARLOTTE, NC, USA

The massive 850-sqft dvLED screen and high-end audio at Blinders Sports Lounge offers guests a 'seeing is believing', unique Vegas-style experience. In partnership with experiential design experts DCBolt Productions, Peerless-AV was honoured to be involved in the unveiling of the new Blinders Sports Lounge on 20th March 2025, ready for the start of the NCAA March Madness Tournament. Blinders Sports Lounge is equipped with the largest immersive dvLED screen on the East Coast, outside of a stadium or casino. Charlotte sports fans will experience the immense, super-wide, high-definition viewing experience of a sportsbook, combined with the live energy of a sports lounge, and the luxurious detailing of a cocktail lounge. Every seat is "the best in the house", thanks to Peerless-AV's Bespoke dvLED Mounting Structure, custom designed and precision engineered with a unique 10-degree forward tilt for optimal viewing wherever guests are seated.



MUNICIPALITY OF ESCHENBACH 📍 ST. GALLEN, SWITZERLAND

Eschenbach municipal council approached full-service marketing agency and reseller KundenMarketing GmbH and its digital signage division Spots On Screen to be the partner on this community project. Several options were proposed for an outdoor display that would seamlessly integrate into a specially designed structure by the customer made of visually striking stone baskets with metal plates. One of the key objectives was that the display must be eye catching, bright and easy to read and, most importantly, durable to withstand all-weather conditions, especially in the coldest Swiss winter months. Peerless-AV's 55" Xtreme™ High Bright Outdoor Displays were chosen as the digital signage solution that would allow KundenMarketing to take its information boards to the next level and create a truly impressive visual presence in the heart of the municipality.



LBBW-FORUM 📍 STUTTGART, GERMANY

One of the most renowned banking institutions, Landesbank Baden-Württemberg, has been completely rebuilt and equipped with a curved concave dvLED vide wall, supported by a custom floor-to-wall substructure. This video wall will allow general meetings and events to take place on site and to be streamed online in the future. LBBW, Sonus, Samsung and Peerless-AV have succeeded in creating a great project they can all be very proud of. Peerless-AV installed a 24x7 SEAMLESS Bespoke dvLED Mounting System for Samsung IEA-F LED displays in 1.5mm pixel pitch, measuring 3.78m x 5.75m. The uniqueness of this installation is that it retains the radius of the existing stage. The dvLED substructure from Peerless-AV safely brings the total weight of 2,358kg to the floor. Thanks to the tri-axis adjustment, laser-cut mounting plates and a precision engineered substructure, the perfect alignment of the 168 cabinets at the radius of 5286mm concave was possible. The result is absolutely impressive: an evenly curved dvLED wall that fits perfectly into the radius of the stage and creates a brilliant image.



Digital Signage



Digital signage makes an impact on nearly every vertical market, whether it be used to communicate to guests, customers, employees, students, or others. While assessing the need for digital signage is usually the first step, evaluating the solutions, which will best serve your goals and how to implement successfully, are equally as important.

Peerless-AV are experts in Digital Signage best practise, with thousands of installations across the globe; in hotels, hospitality venues, retail stores, shopping centres, stadia, museums, corporate offices, universities, control rooms, airports, train stations and more.

From standard products to speciality designed wall mounts, to full-service video wall mounts, to outdoor rated mounts, Peerless-AV leads the way with a full range of high-quality solutions to suit any environment.

PRODUCT SPOTLIGHT

DS-VW775-QR Supreme Full Service Video Wall Mount with Quick Release

Peerless-AV's Supreme Full Service Video Wall Mount raises the bar of excellence with an enhanced feature set centred on ease of install and display alignment.

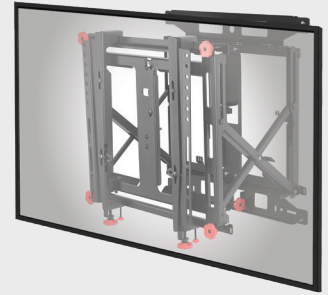

SCREEN SIZE
46" - 60"



MAX LOAD
57kg (125lb)



VESA®
400 x 400mm
up to 600 x 400mm



Quick Push to Release Mechanism

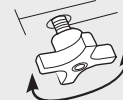

8 Point Micro-Adjustment



Landscape or Portrait Orientation

See page 25 for more information

Education & Training



Peerless-AV's manufacturing capabilities, combined with close cooperation with the leading display OEMs and a keen eye on future technology trends, has enabled the company to stay at the forefront of new product development, especially in the Education and Corporate markets.

Many Peerless-AV mounts, trolleys and stands for monitors, projectors, interactive white boards and the new digital e-boards are installed in learning, training and collaboration facilities, helping users benefit from enhanced ergonomics, safety, mobility and ultimate viewing flexibility.

The various wall mounted or mobile solutions are designed with the user in mind, whilst also perfectly matching the aesthetics of the product they are supporting for a professional look and finish.

PRODUCT SPOTLIGHT

PR598-M Motorised Lift Trolley for 50" to 98" Displays

Mobile Trolley with appealing aesthetics, rigid pre-assembled base and screen height adjustment at the touch of a button.



SCREEN SIZE
50" - 98"



MAX LOAD
130kg (287lbs)



VESA®
Up to 800 x 600mm



Vertical Adjustment with 500mm of travel



One-touch preset digital height settings



Built in pressure sensor for added safety

See page 46 for more information

Peerless-AV has a wide range of 'market specific' mounting solutions. Shown above and throughout this brochure are the range highlights. Contact Peerless-AV to request a dedicated catalogue on any specific market sector or visit www.peerless-av.com for more information.

Corporate & Office



LED is taking off in the corporate space, gradually replacing LCD in boardrooms, meeting rooms and reception areas. Large organisations are installing dvLED video walls that push creative boundaries to support their brand campaigns and achieve maximum impact. Applications range from basic flat-to-wall 130-165" FHD walls where the end user wants to make a bold statement, up to giant and unique bespoke video walls of any size, shape or configuration.

Our expert dvLED team has mastered specialist design and installation techniques to get large scale installs right first time. We are able to support every step of the way through our SEAMLESS dvLED Integration Program; coordinating stakeholders consultants, general contractors, structural engineers, site contractors, installation team, manufactures and end user.

PRODUCT SPOTLIGHT

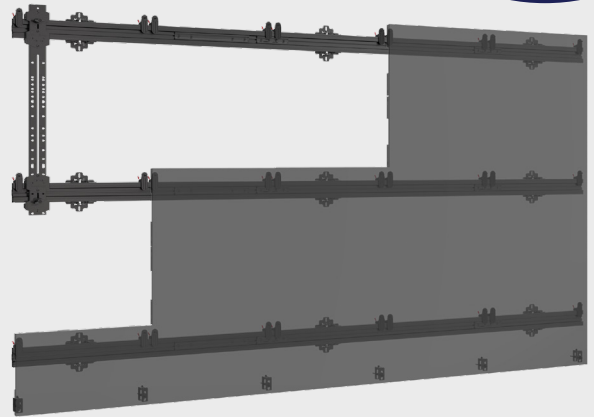

LEDUNV
SEAMLESS CONNECT
Universal dvLED Mounting System

The Peerless-AV® SEAMLESS Connect Universal dvLED Mounting System offers a sleek, flexible design for even greater installation accuracy and time savings. The LEDUNV provides an affordable solution with a patent-pending universal spacer that ensures compatibility with most latching dvLED displays

See page 14 for more information

Retail & Commercial



Retailers are having to evolve to new challenges to stay competitive in the current business climate. Many want to install once and prolong the investment as long as possible, so they are opting for stand out AV technologies that not only attract and drive traffic into stores, but that deliver the highest reliability and longevity.

Peerless-AV products help retailers and commercial businesses to meet their digital communication strategies, be that wayfinding or information gathering via touch screen kiosks, or wow factor merchandise promotion via large format portrait displays.

Our range of indoor kiosks can be personalised in a bespoke colour finish or vinyl wrap to suit the end application, and our mounting systems for LCD and LED videowalls offer the highest level of quality with unmatched time-saving features such as precision adjustment and serviceability.

PRODUCT SPOTLIGHT



KIPC2555-EUK
Indoor Portrait Kiosk

Experience the elegance of Peerless-AV's Portrait Kiosk, designed to support the latest LED displays and touchscreen panels up to 4" deep. From entertaining to wayfinding, this kiosk is an ideal solution for various indoor application settings, including corporate, retail and hospitality.



SCREEN SIZE
from 40" up to 65"



MAX LOAD
125lb (56kg)



Internal Micro-Adjustments



Made in UK,
reducing lead times



Custom Colour Options

See page 66 for more information

Peerless-AV has a wide range of 'market specific' mounting solutions. Shown above and throughout this brochure are the range highlights. Contact Peerless-AV to request a dedicated catalogue on any specific market sector or visit www.peerless-av.com for more information.



Positioning Pixels

With over 85 years of audio visual experience, our commitment to the creation of cutting-edge technology and standard-setting solutions has elevated us to the status of the industry's most innovative leader. Our dedicated SEAMLESS dvLED Solutions Team sets the bar for high quality design, while achieving the pinnacle of aesthetic results. Our dynamic group of dvLED professionals include structural and mechanical engineers, product managers, project managers, installers, as well as sales and service personnel. The entire dvLED Solutions Team is there every step of the way to ensure every customer receives SEAMLESS product support and service.

SEAMLESS CONNECT

The SEAMLESS Connect Universal range presents an entirely different value proposition for integrators and installers, providing them with a mounting system, substructures, and a component set unlike any other on the market – with maximum scalability and endless possibilities for next-level dvLED installations. Engineered to an entirely unmatched specification, the range is exclusively owned, with next day shipment, 50% faster install compared to the previous generation and engineered for limitless size and application versatility. At its heart is the dvLED Mounting System (LEDUNV), available for small, medium and large sizes, accommodating the widest range of dvLED cabinets up to 1220mm wide in landscape and portrait orientations. The mount is the slimmest to wall and most compatible universal mount on the market, scalable to any size or configuration, including large-scale and inside/outside corner-wrapping displays. For dvLED video wall deployments that are not designed to be wall mounted, the new substructure lineup includes floor stand, trolley, floor-to-wall mount, floor-to-ceiling mount and bolt down pedestal models. Engineered to support full system weight with strength and stability, the substructures make dvLED installations even more accessible across all venues regardless of existing wall structures. Corporate, retail, hospitality, transportation, showrooms, live events and entertainment venues will all benefit from the flexibility that this innovation provides.

SEAMLESS BESPOKE

With the Bespoke Series, creativity has no limits. An installation where the dvLED cannot be mounted straight on to a wall, and a substructure is needed, is a perfect example of where Bespoke dvLED mounting systems come into play. Bespoke is generally for extra-large or smaller more complex installs, enabling flexibility for wrapping dvLED around corners, curves and creating angles, where superior precision and tolerances are required. Bespoke solutions can also be created for unique considerations such as to withstand high vibrations or seismic activity.



dvLED Video Wall Configurator

With Peerless-AV's dvLED Video Wall Configurator, you are now able to seamlessly design a dvLED video wall and request a quote within minutes. The online configurator streamlines the process for customers and speeds up your development and delivery time. The ultra-useful configuration tool provides additional critical information, such as mount weight, video wall power consumption, display resolution, and technical drawings. This innovative technology is easy to use and sets a new standard for the dvLED Video Wall market.



SCAN TO GET STARTED

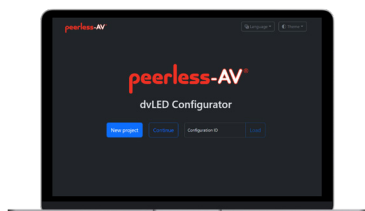

**QUICK & EASY
VIDEO WALL
CONFIGURATION**



**PROVIDES
VIDEO WALL
SPECIFICATIONS**



**REQUEST A
QUOTE WITHIN
MINUTES**



**OFFERS
QUOTE HISTORY
STORAGE**

Compatible dvLED Display Brands*

Abgen

AOTO

BARCO

BOE

CHKISTIE®

ahua
TECHNOLOGY

DAKTRONICS

FABULUX LED

HIKVISION®

Hisense

INFILED

Jupiter

**JUST
VIDEO
WALLS..**

LEYARD
PLANAR

LG Business Solutions

LINSNLED

MAXHUB

PHILIPS

QST
Quality Systems Technology

SAMSUNG

SHARP

SNA DISPLAYS™

SONY

Unilumin

VESTEL

*Please visit the product webpage, or contact a Peerless-AV® Sales Representative, for the current list of compatible latching dvLED display models.



SEAMLESS CONNECT

Universal dvLED Mounting Systems

NEW

LEDUNV Models

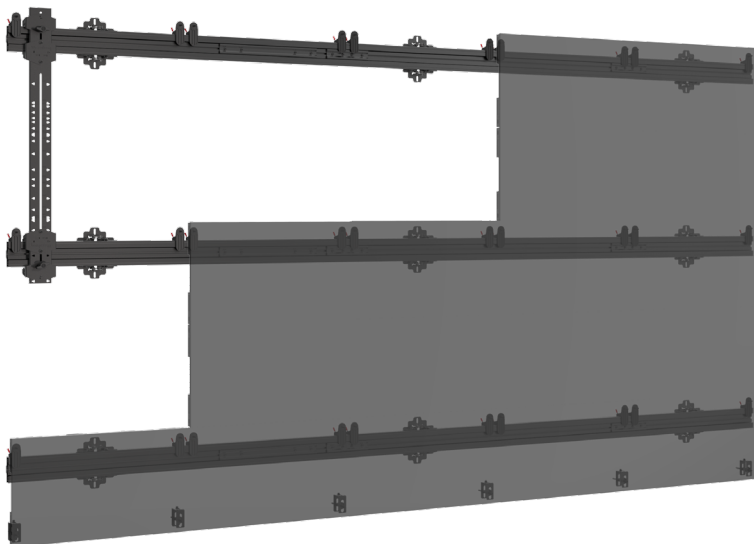

LEDUNVS-5X5 shown

*Universal spacer (LEDUNVSPACER3) is sold separately.

- Engineered for versatility, accommodating both corner and flat-to-wall installations
- Ultra-thin design maintains a minimal 40mm depth, ensuring ADA compliance for various dvLED displays
- Scalable design enables unlimited configurations
- Adapts to uneven walls of any size for a precise fit with 40mm z-axis adjustment
- Quick-connect clamps are manufactured with durable cast aluminium construction that deliver superior strength and secure clamping force
- The patent-pending universal spacer* ensures accurate extrusion spacing and allows the installer to work hands-free, streamlining the wall plate installation process
- High-strength components support alternate row and column mounting to streamline install and reduce labour
- Included with LEDUNVS and LEDUNVL, extrusion expansion joint can eliminate on-site cutting, streamlining the installation process in the majority of installs

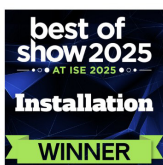



The Peerless-AV® SEAMLESS Connect Universal dvLED Mounting System offers a sleek, flexible design for even greater installation accuracy and time savings. The LEDUNV provides an affordable solution with a patent-pending universal spacer that ensures compatibility with most latching dvLED displays. The mount frame allows for X, Y, and Z axis adjustments to accommodate uneven walls and ensure a flat video wall. Its lightweight aluminum frame installs quickly, and the quick-connect clamps make securing the displays to the mount frame simple for installers.

Unique Key Features

Universal Spacer ■

Ensures exact positioning of horizontal extrusion without installer measuring and calculations. Works for single and double stacked cabinets as well as displays installed in portrait orientation. With simple height setting and ease of use this installer friendly tool is guaranteed to streamline any installation.

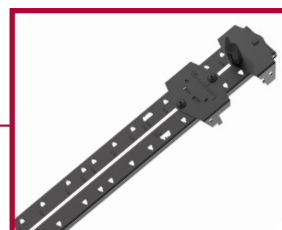

Scalable and Reconfigurable

The LEDUNV models are available in small, medium and large sizes, accommodating the widest range of dvLED cabinets up to 1220mm wide in landscape and portrait orientations. The scalable design enables unlimited sizes and configurations.



Versatile Design ■

The lightweight aluminium frame is quick and simple to install and can easily be configured to support projects with internal and external corners. The sleek, flexible design is the closest to wall universal mounting solution, with features to ensure even greater installation accuracy and time savings.



Wall Plate Adjustment ■

Depth adjustment is vital to achieve a perfectly flat display even on uneven wall surfaces. The LEDUNV wall plate includes industry-leading 40mm depth adjustment with a precision gear mechanism providing smooth arm movement without binding or twisting.

Fine Adjustment

Additional 6mm post install clamp height micro-adjustment delivers perfect positioning at all points.

Eliminate On-site Cutting ■

Included with LEDUNVS and LEDUNVL, the extrusion expansion joint can eliminate on-site cutting by increasing overall mount width by up to 160mm, streamlining and simplifying the installation process in the majority of installs.



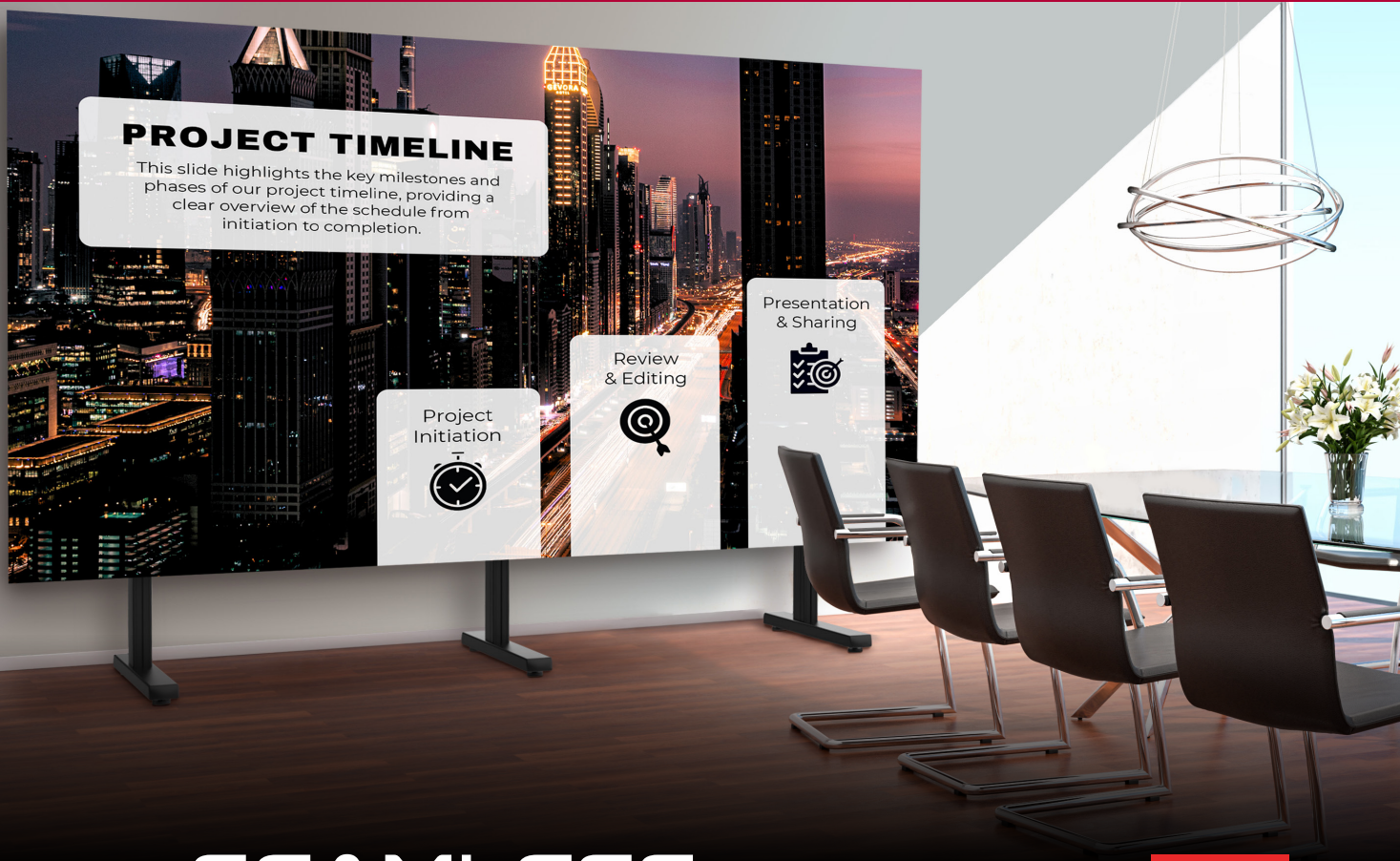

SEAMLESS CONNECT NEW

Universal Substructures: Versatile dvLED Mounting Solutions

Universal Mobile Trolley

LEDMT Models

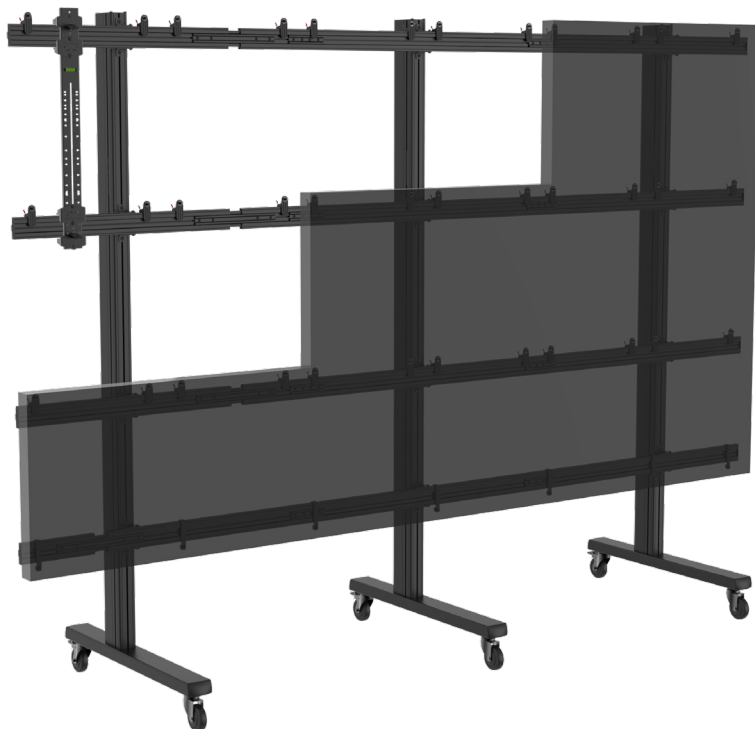

LEDMTS-6X6 shown

*Universal spacer (LEDUNVSPACER3) is sold separately.

- Adaptable solution for installations where mounting direct to a wall is not an option
- Slim, space saving design fits neatly in any installation environment
- Lightweight, anodised aluminium frame for simple shipping, convenient handling, easy installation and a durable, decorative appearance
- Modular design provides scalability in installation configuration and size
- Robust vertical support provides a maximum height of 3m for mobile trolley (*max height for other substructure models varies*)
- Integrated cable management contains and conceals cables for a professional installation
- High-Strength components support alternate row mounting to streamline installation and reduce labour costs
- Patent-Pending universal spacer ensures accurate extrusion spacing
- Optional trim kit accessory (LEDTK) offers compatibility with most displays

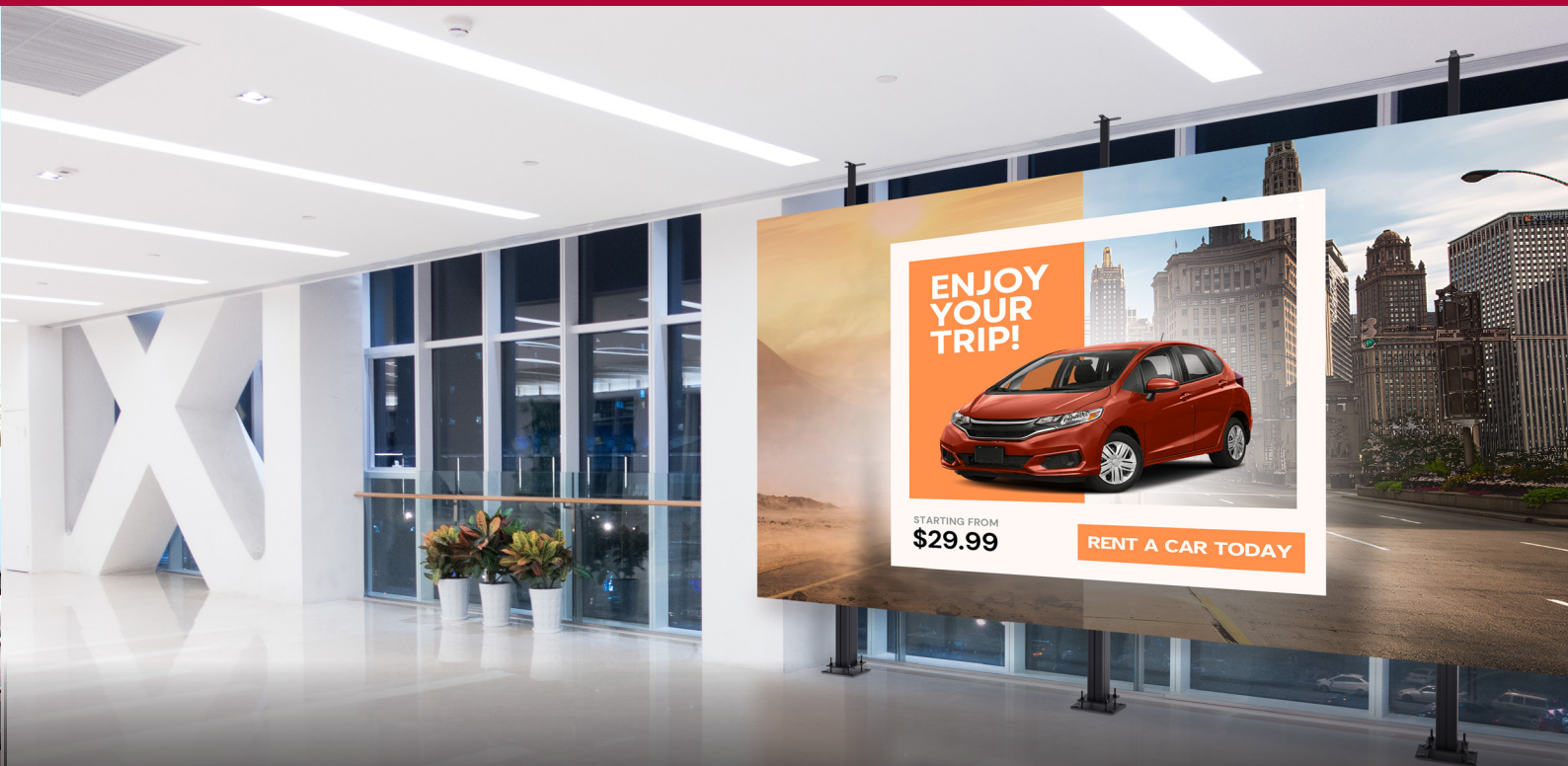

The SEAMLESS Connect Universal Series offers a versatile lineup of substructures for environments where wall mounting is not an option. Purpose-built for dvLED video walls and all-in-one displays, these solutions support full system weight with exceptional strength and stability. Slim, space-saving designs simplify setup and accelerate installation - Ideal for corporate lobbies, retail spaces, hospitality venues, showrooms, events, and entertainment settings.

Universal Floor Stand

LEDFS Models

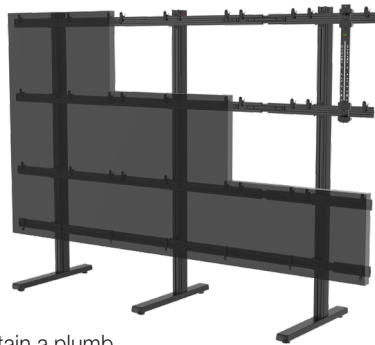

Integrated leveling feet maintain a plumb structure, even on uneven surfaces, ensuring optimal alignment and display performance

Universal Bolt-Down

LEDBD Models

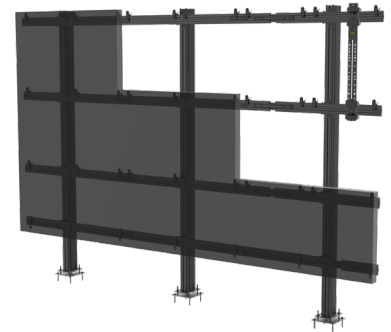

Quad-post leveling base allows precise micro-adjustments at all four corners to create a perfectly flat and stable mounting surface

Universal Floor-to-Wall

LEDFW Models

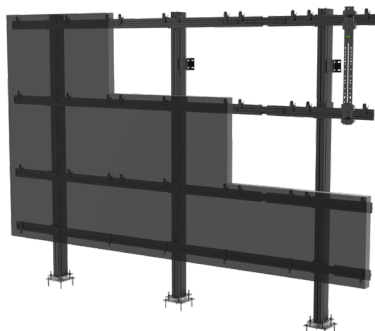

Quad-post leveling base and adjustable wall tie-back brackets ensure a flat mounting surface and a plumb structure for secure, wall-supported installations

Universal Floor-to-Ceiling

LEDFC Models

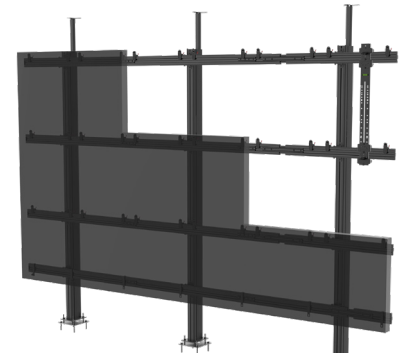

Quad-post leveling base and ceiling-attach brackets ensure a flat mounting surface and a plumb structure in ceiling-supported configurations



SEAMLESS CONNECT NEW

Universal Trim Kit

LEDTK Models



- Outer Trim Kit, powder-coated with moulded corners creates a polished, high-end appearance from edge to edge
- Compatible with Peerless-AV® SEAMLESS Connect Universal Wall Mounts and Substructures (LEDUNV Models)
- Sleek Trim Kit elegantly completes the video wall, seamlessly concealing the exposed edges of the dvLED display
- Available in both solid and vented styles, the trim options let you choose the ideal combination to suit your installation
- Depth-adjustable design accommodates depth range from 66mm to 150mm, ensuring flexibility for various installation needs
- Designed for on-site customisation, the Trim Kit can be cut to length in the field, making it easy to stock and ready for immediate shipment
- Each 1220mm trim section is packaged in compact, easy-to-handle cardboard boxes - reducing environmental impact, and lowering shipping costs

SEAMLESS KITTED DEDICATED



**Flat dvLED Mounting System for LG
Magnit Direct View LED Displays**



The Peerless-AV SEAMLESS Kitted Series Flat dvLED Mounting System (DS-LEDLSAA) is specifically crafted for the LG Magnit Series Direct View LED Displays. It features a slim, space-efficient, and visually pleasing design suitable for various configurations. Equipped with integrated cable management, user-friendly hanging hardware, and a lightweight aluminium frame, this system allows integrators to effortlessly create the ideal video wall.

Model	Full HD Size	Ultra HD Size
LSAB007	N/A	DS-LEDLSAA-5X5
LSAA009	DS-LEDLSAA-3X3	DS-LEDLSAA-6X6
LSAB009		
LSAA012	DS-LEDLSAA-4X4	DS-LEDLSAA-8X8
LSAB012		

SEAMLESS KITTED DEDICATED



**Flat dvLED Mounting System for Samsung
IEA, IER, IFR and IWC Series Direct View LED Displays**

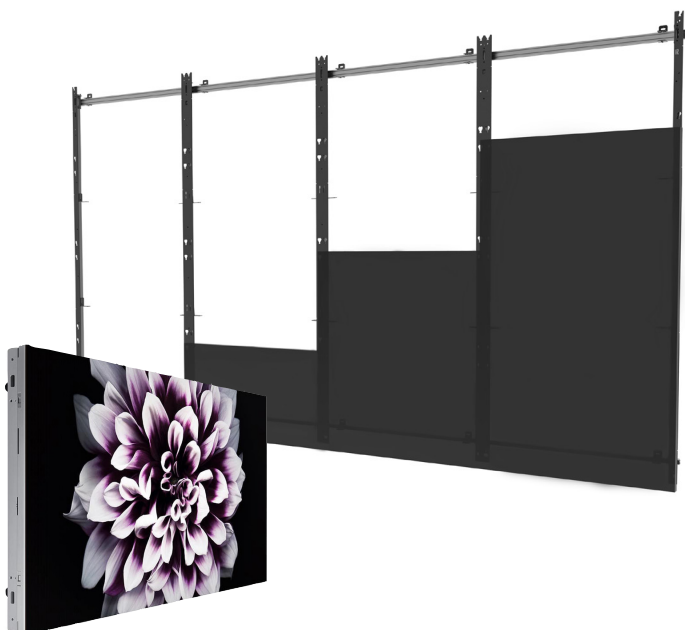

Peerless-AV's SEAMLESS Kitted Series Flat dvLED Mounting System (DS-LEDIER) is designed exclusively for the Samsung IEA, IER, IFR and IWC Series Direct View LED Displays, offering slim, space-saving, and aesthetically appealing designs for multiple configurations. With integrated cable management, easy-hang hardware, and a lightweight aluminium frame, integrators can quickly and easily build the perfect video wall.

Model	Full HD Size	Ultra HD Size
IE015R / IF015R / IE015A	DS-LEDIER-3X3	DS-LEDIER-6X6
IE020R / IF020R / IE020A	DS-LEDIER-4X4	DS-LEDIER-8X8
IE025R / IF025R / IE025A	DS-LEDIER-5X5	DS-LEDIER-10X10
IW008C	DS-LEDIWC-2X2	DS-LEDIWC-4X4
IW012C	DS-LEDIWC-3X3	DS-LEDIWC-6X6
IW016C	DS-LEDIWC-4X4	DS-LEDIWC-8X8



SEAMLESS CONNECT

The SEAMLESS Connect Universal Series can also provide a support structure to convert All-in-One dvLED displays from the leading manufacturers from wall mounted to a mobile, free standing or floor mounted solution

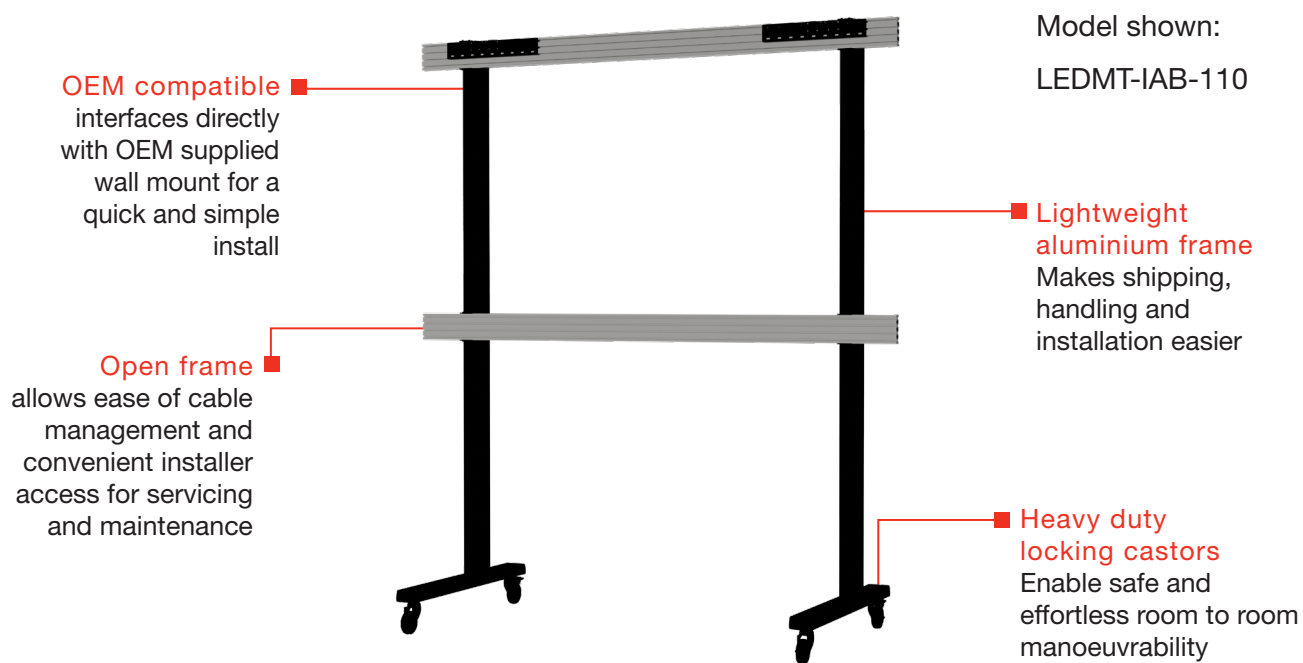

Also available as:

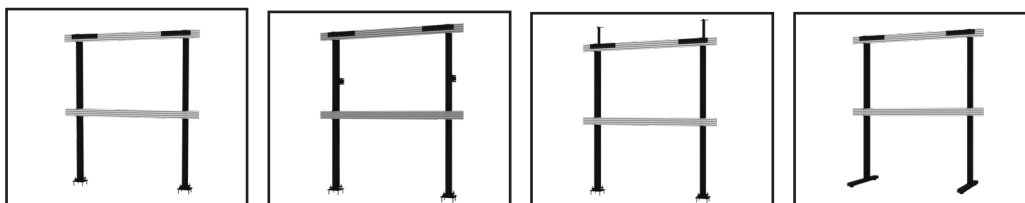

Bolt-Down

Floor-to-Wall

Floor-to-Ceiling

Free Standing

All-in-One Models Compatibility Chart

Brand	Model	Mobile Trolley	Free Standing
	ICONX 108"	LEDMT-ICONX-108	LEDFS-ICONX-108
	ICONX 136"	LEDMT-ICONX-136	LEDFS-ICONX-136
	ICONX 163"	LEDMT-ICONX-163	LEDFS-ICONX-163
	LAPA 136"	LEDMT-LAPA-136	LEDFS-LAPA-136
	LAPA 163"	LEDMT-LAPA-163	LEDFS-LAPA-163
	LAAA 136"	LEDMT-LAAA-136	LEDFS-LAAA-136
	LAAA 163"	LEDMT-LAAA-163	LEDFS-LAAA-163
	LABA 136"	LEDMT-LABA-136	LEDFS-LABA-136
	HDL5000 135"	LEDMT-HDL5000-135	LEDFS-HDL5000-135
	IAB 110"	LEDMT-IAB-110	LEDFS-IAB-110
	IAB 146"	LEDMT-IAB-146	LEDFS-IAB-146
	IAC 130"	LEDMT-IAC-130	LEDFS-IAC-130
	MMF-A 136"	LEDMT-MMFA-136	LEDFS-MMFA-136
	UTV SC 108"	LEDMT-UTVSC-108	LEDFS-UTVSC-108
	UTV SC 135"	LEDMT-UTVSC-135	LEDFS-UTVSC-135
	UTV SC 162"	LEDMT-UTVSC-162	LEDFS-UTVSC-162
	UTV W 136"	LEDMT-UTVW-136	LEDMT-UTVW-136
	UTV W 163"	LEDMT-UTVW-163	LEDMT-UTVW-163
	LDM 136"	LEDMT-LDM-136	LEDFS-LDM-136
	LDM 163"	LEDMT-LDM-163	LEDFS-LDM-163
	LDP 136"	LEDMT-LDP-136	LEDFS-LDP-136
	LDP 163"	LEDMT-LDP-163	LEDFS-LDP-163

Visit Peerless-AV.com for the current list of compatible dvLED display models



SEAMLESS BESPOKE

Custom dvLED Mounting Systems

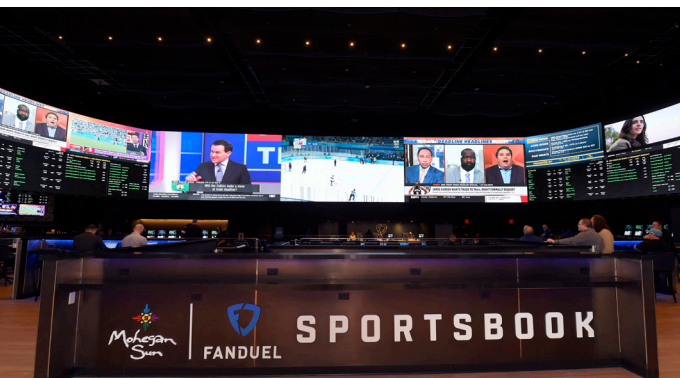



Peerless-AV® provides an innovative approach to all our services - both indoors & outdoors. Specialising in custom dvLED solutions, we strive to stay on the cutting edge of what the industry has to offer. We are equipped to work in a variety of markets & environments, giving our customers endless design options (flat, corner or curved configurations).

Contact our dedicated dvLED solutions team today to discuss your next project or visit dvledconfigurator.peerless-av.com and learn how Peerless-AV can support your vision.

+44 (0) 1923 200 100

sales@peerless-av.eu.com

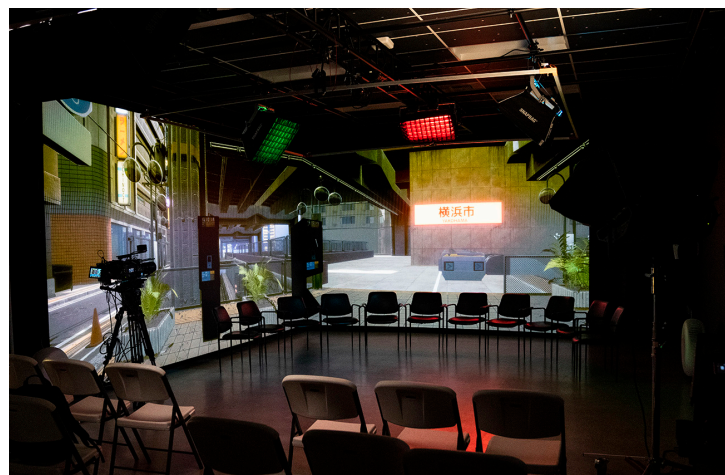

Digital Signage Mounting Solutions



Excellence in Digital Signage starts with outstanding content and screen placement.

Peerless-AV mounting solutions have been deployed in thousands of locations all around the globe. Integrators, installers and network administrators have trusted Peerless-AV mounts for quality, durability and ease of installation for decades.

From standard products to custom designed speciality mounts, Peerless-AV leads the way in Digital Signage with aesthetics, logistics and creative, high quality solutions to suit any requirement.

Peerless-AV understands the challenges facing installers and integrators and our experience in the market has led to the creation of mounts that are packed with innovative features that offer up to a 60% reduction in installation time.

All the Peerless-AV video wall mounts have the added option of screen specific spacers, custom made to the dimensions of individual models to eliminate on-site measuring to ensure perfect display alignment every time.

Additional features allow ease of access for servicing and maintenance, which contributes to an installer-friendly experience.

Trust Peerless-AV to help you create outstanding Digital Signage with their innovative mounting solutions. For more information on additional Digital Signage products that are available please contact Peerless-AV sales at sales@peerless-av.co.uk or call +44 (0)1923 200 100.



TIME SAVING FEATURES

- SAVING YOU UP TO 60% OF INSTALLATION TIME

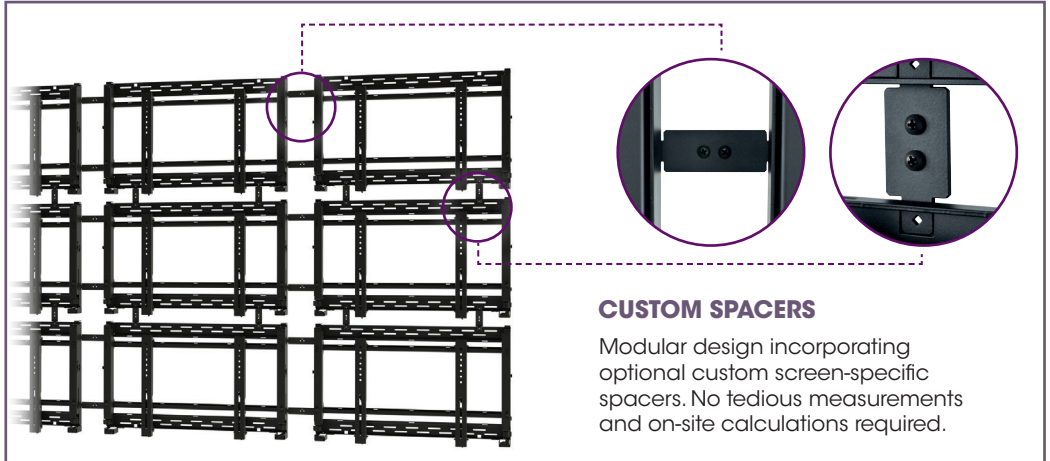

CUSTOM SPACERS

Modular design incorporating optional custom screen-specific spacers. No tedious measurements and on-site calculations required.

KEYHOLE WALL PLATE

Easy hang keyhole wall plate speeds up the mount positioning and allows for a single person install

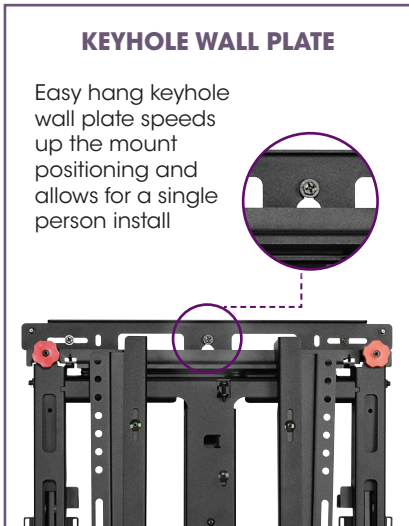

EIGHT POINT FINE ADJUSTMENT

Simple, tool-less micro-adjustments at 8 points seamlessly align the displays

Corner forward & back adjustment

Vertical adjustment

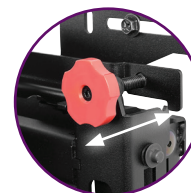
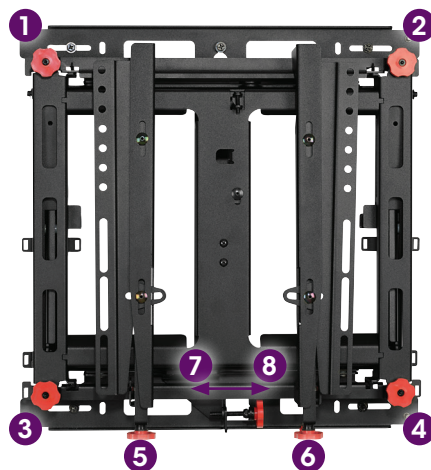

Points 1-4

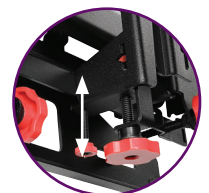

Points 5&6

Supreme Full Service Video Wall Mount with Quick Release

Flat Panel Displays 46" to 60" - Landscape/Portrait

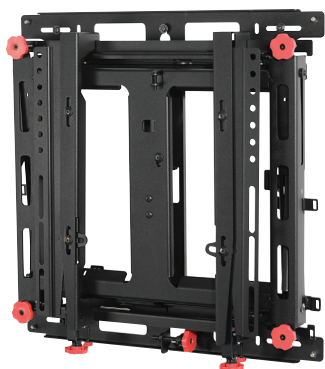

- Gentle press to release mechanism provides convenient display access
- Security hardware option deters tampering and theft
- Accommodates displays in both landscape and portrait orientation
- Modular mount for unlimited video wall display configurations
- Integrated cable management tie-backs make display-to-display cabling simple
- Compatible with ACC adaptors sold separately to convert from VESA® 600x400mm to 800x400mm mounting pattern
- Tool-less lateral micro-adjustment, offering 38mm of fine tune adjustment on each of the X, Y and Z axis
- Easy hang keyhole wall plate speeds up the mount positioning and allows for a single person install



Effortless Precision

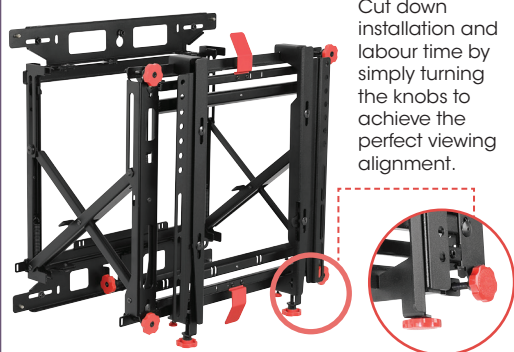

Cut down installation and labour time by simply turning the knobs to achieve the perfect viewing alignment.

DS-VW775

Quick release



Spring loaded push release mechanism for quick & convenient access to mid-array & recessed displays.

Custom Spacers



DS-VWRS reusable display dedicated wall spacers eliminate guesswork and on-site installation calculations.

Technical Specifications

Part No.	Screen Size	Colour	Max. weight	Distance from wall	Mounting pattern
DS-VW775-QR	46-60"+	Black	57kg (125lbs)	80-118mm without adaptors (closed) 99-137mm with adaptors (closed) 351mm without adaptors (extended) 370mm with adaptors (extended)	Up to VESA 400x400mm without adaptors Up to VESA 600x400mm with adaptors
DS-VW775	46-60"+	Black	57kg (125lbs)	80-118mm without adaptors (closed) 99-137mm with adaptors (closed) 356mm without adaptors (extended) 375mm with adaptors (extended)	Up to VESA 400x400mm without adaptors Up to VESA 600x400mm with adaptors

Full-Service Landscape Video Wall Mount

- Modular mount for unlimited video wall display configurations
- Tool-less micro-adjustments at 8 points seamlessly align the displays
- Displays click securely into place against the wall with spring-loaded mechanism
- Displays and mounts sit flush against the wall for a clean side appearance
- Pull-out/prop-open action for quick service access
- Integrated cable management tie-backs make display-to-display cabling simple
- Custom wall plate spacers eliminate the guesswork and on-site installation calculations
- Extended compatibility with the ACC-V900X to accommodate VESA® patterns up to 900 x 400 / 700 x 900mm

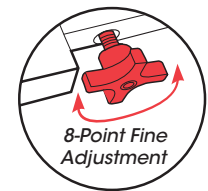

Technical Specifications

Part No.	Screen Size	Colour	Max. weight	Distance from wall	Mount pattern
DS-VW765-LAND	40 - 65" +	Black	57kg (125lbs)	78 - 97mm (closed) 294mm (extended)	Up to VESA® 700 x 400mm
DS-VWSxxx	Contact Peerless-AV for screen specific spacers				

Full-service Quick Release Video Wall Mount

Flat Panel Displays up to 65" - Landscape



- Easy-to-use pop out mechanism provides quick service access, even for in-wall applications, while spring loaded mechanism securely clicks the display back into place
- Quick release can be restricted with a locking screw when feature is not needed
- Overall depth is equivalent to existing VW765 / VW665 models enabling mixed product video wall arrays
- Carriage extension force can be adjusted to accommodate the weight of the display
- Modular mount for unlimited video wall display configurations
- Tool-less micro-adjustments at 8 points seamlessly align the displays
- Easy hang keyhole wall plate speeds up the mount positioning and allows for a single person install
- Custom wall plate spacers eliminate the guesswork and on-site installation calculations
- Extended compatibility with the ACC-V900X to accommodate VESA® patterns up to 900 x 400 / 700 x 900mm



Technical Specifications

Part No.	Screen Size	Colour	Max. weight	Distance from wall	Mounting pattern
DS-VW765-LQR	46 - 65" +	Black	57kg (125lbs)	78 - 97mm (closed) 294mm (extended)	Up to VESA® 700 x 400mm

Large Format Quick Release Video Wall Mount

Flat Panel Displays up to 98"



- Easy-to-use pop out mechanism provides quick service access, even for in-wall applications, while spring loaded mechanism securely clicks the display back into place
- Quick release can be restricted with a locking screw when feature is not required
- Universal adaptors accommodate VESA® patterns up to 600x600mm in both landscape and portrait orientation
- Carriage extension force can be adjusted to accommodate the weight of the display
- Modular mount for unlimited video wall display configurations
- Tool-less micro-adjustments at 8 points seamlessly align the displays
- Integrated cable management tie-backs make display-to-display cabling simple
- Easy hang keyhole wall plate speeds up the mount positioning and allows for a single person install

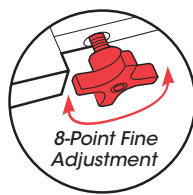

• **Optional accessories:**

ACC-V900X which enable VESA® mounting patterns of up to 900 x 600mm / 600 x 900mm for Landscape or Portrait orientations.

ACC-V1500X which enable VESA® mounting patterns of up to 1200mm or 1500mm for Landscape or Portrait orientations.

Technical Specifications

Part No.	Screen Size	Colour	Max. weight	Distance from wall	Mounting pattern
DS-VW795-QR	65 - 98"+	Black	102kg (225lbs)	93-113mm (closed) 410mm (extended)	Up to VESA® 600 x 600mm

Ultra Slim Quick Release Video Wall Mount

Flat Panel Displays up to 65" - Landscape/Portrait



- Ultra slim design, at only 48mm overall depth from the wall, ideal to complement the latest ultra thin panels for a truly discreet and stylish video wall installation
- Quick release pop out mechanism provides convenient display access in recessed applications
- Quick release can be disabled with a locking screw to prevent unintentional pop-outs
- Display automatically extends into a negative tilt position for ease of service
- Tool-less micro-adjustments at 8 points allows the mount to overcome uneven walls to create a seamless video wall display
- Accommodates displays in both landscape and portrait orientation
- Modular mount for unlimited video wall display configurations
- Integrated cable management tie-backs make display-to-display cabling simple
- Easy hang keyhole wall plate speeds up the mount positioning and allows for a single person install
- Reusable custom wall plate spacers eliminate the guesswork and on-site installation calculations
- Compatible with ACC-V600X adaptors sold separately to convert to VESA® 600x400mm mounting patterns

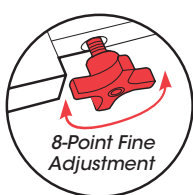

Technical Specifications

Part No.	Screen Size	Colour	Max. weight	Distance from wall	Mounting pattern
DS-VW755S	46 - 65"+	Black	36kg (80lbs)	48-67mm (closed) 328mm (extension)	Up to VESA® 400x400mm

Ultra-Slim Video Wall Mount

- Modular design allows creation of unlimited video wall display configurations
- Dedicated wall plate spacers available for each specific screen to eliminate on-site guesswork and screen spacing calculations
- Horizontal adjustment makes aligning screens quick & easy
- Ultra-slim design provides a streamlined profile at only 17.5mm depth
- Durable locking rails hold screen ensuring a safe and secure installation
- Includes security hardware that helps deter tampering and loss
- VESA® 200x200mm up to 600x400mm compliant in 100mm increments - additional patterns supported with adaptor plates



Technical Specifications

Part No.	Screen Size	Max. weight	Mounting pattern
DS-VW650	40"+	34kg (75lbs)	Up to VESA® 600x400mm
DS-VWSxxx	Contact Peerless-AV for screen specific spacers		

Universal 2x2 Video Wall Mount

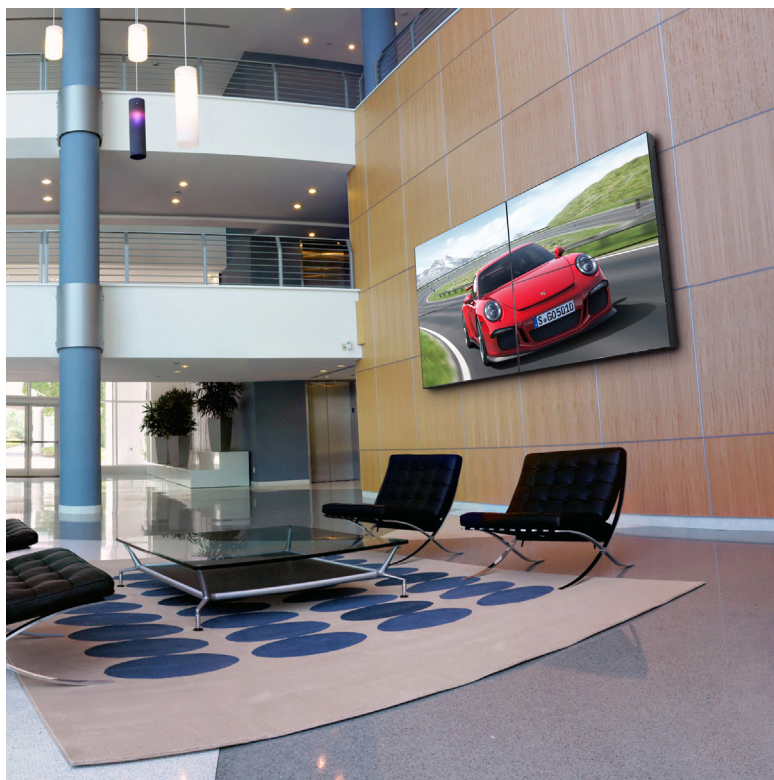

- Single box solution for 2x2 video wall mounting, ships in one box (1200 x 454 x 127mm)
- Horizontal adjustment makes mounting and aligning displays quick and easy
- Compatible with most narrow bezel displays ranging from 46" to 55"
- Included security screws deter tampering and theft
- Thin design measures just 2.33" (59mm) deep
- Fully VESA® compliant - check compatibility formula for guaranteed fitment

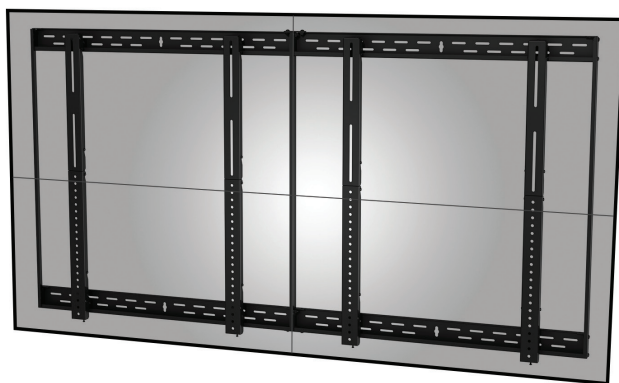

Technical Specifications

Part No.	Screen Size	Max. weight	Mounting pattern
DS-VW655-2X2	46-55"	272kg (600lbs)	Universal

Video Wall Trolleys and Pedestal Stands

For 2x2, 3x2, 4x2, 1x3, 3x3 & 4x3 Configurations



Peerless-AV takes video wall trolleys and stands to a new level of innovation. This Peerless-AV's Modular Video Wall Pedestal Mount encompasses an assortment of useful features that eliminate the need for extra tools and hardware, all while ensuring your application is secure and looks professional. The tool-less micro adjustments at 8 points offer precise and effortless alignment of the displays. Built-in cable management and media storage help create a clean, professional appearance and provide a safe central location to house your components.

- Designed for quick set-up and tear-down- ideal for temporary signage and Rental & Staging applications
- Precision manufactured from high quality materials to create a sturdy design capable of supporting over 400kg (3x3 model)
- Aluminium frame reduces the overall weight and shipping costs and aids trolley movement even with displays in situ
- VESA® 200 x 200 up to 600 x 400mm compatible

NO TOOLS REQUIRED FOR MICRO-ADJUSTMENT
Simple, tool-less micro-adjustment at 8 points seamlessly align the displays

QUICK CONNECT LATCH
to auto engage displays to mounting rails for quick and easy assembly

QUICK SET UP AND TEAR DOWN
Engineered to reduce installation time and cost

BOLTS DIRECTLY
to concrete without requiring additional connections to the wall or ceiling

LEVELLING FEET
available to replace castors on trolley models
ACC310VWC4 / ACC310VWC6

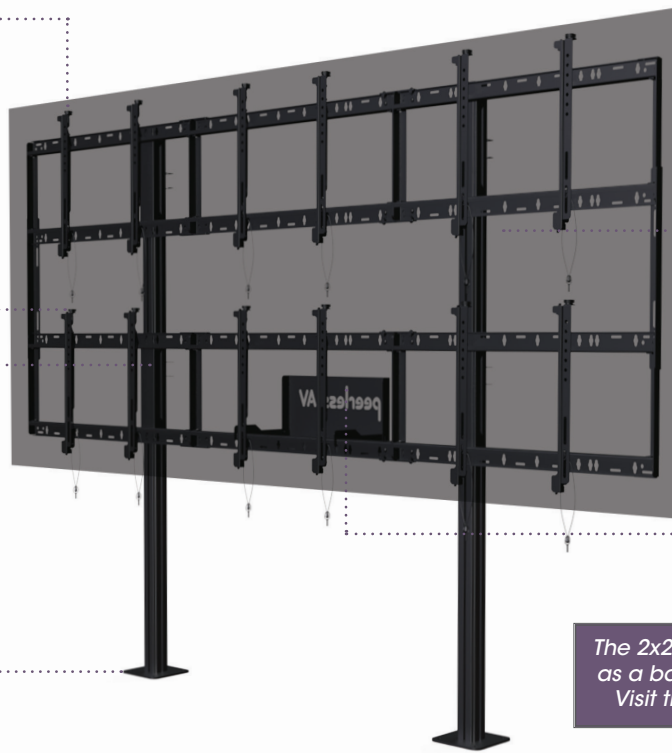

ALUMINIUM FRAME
reduces overall weight and shipping costs and aids movement
(trolley models)

CABLE MANAGEMENT
through rear adjustable cable centralising brackets for a professional appearance

MEDIA STORAGE
Rear shelf provides a secure central location and clean aesthetics

The 2x2 video wall stand is also available as a back-to-back version, DS-S560-B2X2. Visit the website for more information.

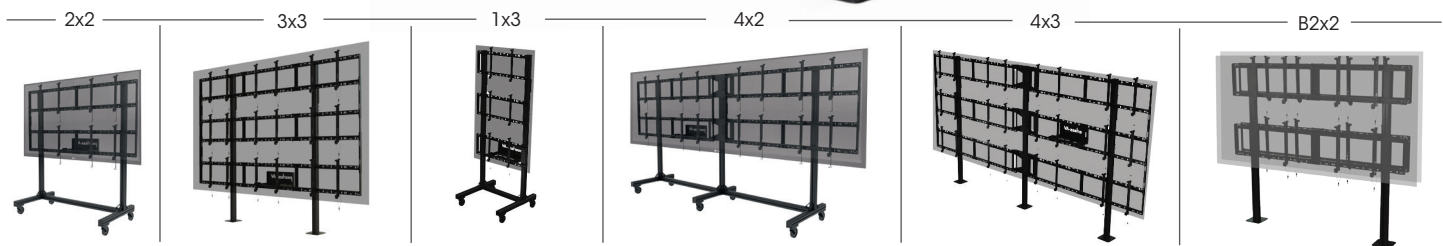

Technical Specifications

Part No.	Screen Size	Max. weight	Mounting pattern	Configuration
DS-C560-2X2/DS-S560-2X2	46" to 60" *	227kg	Up to VESA® 600 x 400	2x2
DS-C555-3X2/DS-S555-3X2	46" to 55" *	272kg	Up to VESA® 600 x 400	3x2, 2x2
DS-C555-4X2/DS-S555-4X2	46" to 55" *	363kg	Up to VESA® 600 x 400	4x2, 3x2, 2x2
DS-C560-1X3/DS-S560-1X3	46" to 60" *	170kg	Up to VESA® 600 x 400	1x3
DS-C555-3X3/DS-S555-3X3	46" to 55" *	409kg	Up to VESA® 600 x 400	3x3, 3x2, 2x2
DS-C555-4X3/DS-S555-4X3	46" to 55" *	545kg	Up to VESA® 600 x 400	4x3, 4x2, 3x3, 3x2, 2x2
DS-S560-B2X2	46" to 60"	363kg	Up to VESA® 600 x 400	Back-to-Back 2x2

* Max display depth 127mm (5")

Digital Menu Board Mount

Simple Selection, Simple Installation, Simply Seamless



Expand your options for linear display installations by utilising the new Digital Menu Board System from Peerless-AV. This innovative system enables simple and customisable mount selection to your specific requirements, with the added benefit of easy installation resulting in a seamless, in-line array of flat panel displays.

Supporting virtually any digital signage or menu board system - from a dual screen to a limitless row of screens - this seamless multi-screen mounting solution opens up a multitude of installation possibilities for any market from transportation information arrays to QSR menu displays.

8 POINT MICRO ADJUSTMENT
Provides post installation display alignment on the x, y and z axis

CONNECTING WALL PLATES
Creates a continuous mounting surface

TOOL-LESS HEIGHT ADJUSTMENT
Provides post installation leveling and display alignment

PRECISION TILT
Continuous and fixed tilt from 0° to 15° ensures all displays are at the same angle

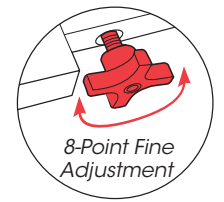

8-Point Fine Adjustment

CONVENIENT CABLE ACCESS
Sturdy kickstand holds the display away from the wall during service

QUICK CONNECT LATCH
Positively engages wall plate when mounting display for speedy set-up

HORIZONTAL ADJUSTMENT
Provides a seamless appearance



Convert a wall mount to a ceiling mount with adaptors:
ACC-MBCR1
ACC-MBF

ACC-MB0800/2200/3500/3875 and DS-MBZA
Additional menu board wall plates and adaptor rails can be used to widen the mounting surface for compatibility with larger displays.
Visit www.peerless-av.com for more details

Ceiling Mount 2x1 & 3x1 Kits

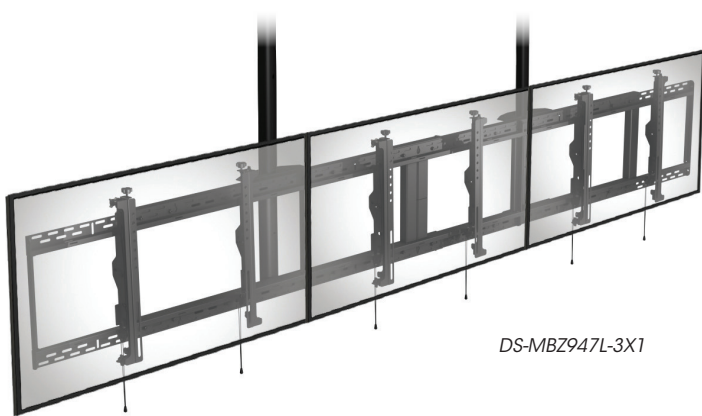

DS-MBZ947L-3X1

The Peerless-AV Digital Menu Board system is also available as a ceiling mount kit, with all the same features and benefits for a quick and intuitive installation experience. All models are compatible with standard extension columns and ceiling plate options to overcome a wide variety of mounting variations and challenges.

Kits include 2x1 and 3x1 configurations for both 42" and 47" display sizes in landscape orientation. All models feature full 8-point adjustment, including vertical movement on each display adaptor bracket for post-installation leveling and height adjustment fine tuning.

The fixed tilt settings on each adaptor arm ensures that all displays are set to the same angle for a consistent viewing appearance.

Technical Specifications

Model	Screen Size	Orientation	Max Weight	Mounting Pattern	Features
DS-MBZ642L	40" to 42"	Landscape	45kg (100lb)	880 x 400mm (34.65 x 15.75")	Full Tilt, Height + 8-Point Tool-less Micro Adjustment
DS-MBZ647L	46" to 65"	Landscape	45kg (100lb)	975 x 400mm (38.4 x 15.75")	
DS-MBZ647P	42" to 65"	Portrait	45kg (100lb)	550 x 400mm (21.65 x 15.75")	
DS-MBZ942L-2X1	40" to 42"	Landscape	91kg (200lb)	1769 x 400mm (69.65 x 15.75")	Twin display ceiling mount - Full Tilt, Height + Tool-less 8-Point Micro Adjustment
DS-MBZ947L-2X1	46" to 55"	Landscape	91kg (200lb)	1960 x 400mm (77.15 x 15.75")	
DS-MBZ942L-3X1	40" to 42"	Landscape	136kg (300lb)	2658 x 400mm (104.65 x 15.75")	Triple display ceiling mount - Full Tilt, Height + Tool-less 8-Point Micro Adjustment
DS-MBZ947L-3X1	46" to 48"	Landscape	136kg (300lb)	2944 x 400mm (115.9 x 15.75")	

Universal In-Window Bolt-Down Pedestal Mount

Space saving support structure for single screen applications

- Accommodates displays in landscape and portrait orientation
- Vertical height adjustment* enables display to be located anywhere along the column up to 1.7m to screen centre
**at time of install*
- Integrated cable management protects, contains and conceals cables for a clean, professional installation
- Fits displays with VESA® mounting patterns from 200 x 100 up to 600 x 400mm
- Sleek & durable black anodised finish for a long lasting, scratch resistant appearance
- Lightweight aluminium column reduces shipping costs, while simplifying onsite handling and installation.
- Easy and quick installation

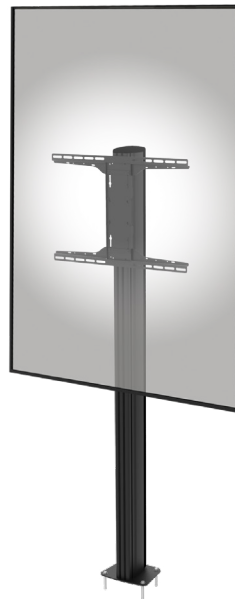

Technical Specifications

Part No.	Screen Size	Max Weight	Mounting Pattern
PC575-UNL	32 - 75"	60kg (132lbs)	Up to 600 x 400mm

Floor and Ceiling Window Display Mounts

For **SAMSUNG** OM55N-D double-sided displays

Peerless-AV's Floor and Ceiling Window Display Mounts are designed exclusively for Samsung OMN-D Series. This sleek, double-sided mount is the ideal solution to showcase eye-catching, digital signage content that can be seen from both inside and outside a store window. With a multitude of installer friendly features, including concealed cable management for a professional appearance, this versatile solution can be adapted to suit a wide range of retail and commercial applications.



- EASILY MOUNTABLE to wood joists or concrete with included hardware
- CONCEALED CABLE MANAGEMENT For a sleek and professional appearance
- SLIM PROFILE Mount is designed to complement the sleek look of the Samsung display



ACC-OMD-FLOOR

Free standing base accessory also available
Visit www.peerless-av.com for more details

Technical Specifications

Part No.	Compatible With	Floor or Ceiling Mounted	Height
DS-OM55ND-FLOOR	55" Samsung OM55N-D	Floor	65" (1650mm) to the centre of display
DS-OM55ND-CEIL	55" Samsung OM55N-D	Ceiling	53" (1350mm) to the centre of display

Round Column Mount

For digital signage displays

The perfect, indoor solution for mounting digital signage displays around 7.9" to 31.5" (200-800mm) round columns. The CMAL offers a plethora of features for safe and easy installation, and is compatible with nearly all of Peerless-AV's SmartMount® products, including landscape and portrait mounts. Ideal for stadiums, arenas, and more, the Round Column Mount provides a solution for attaching digital signage displays to various diameter columns.

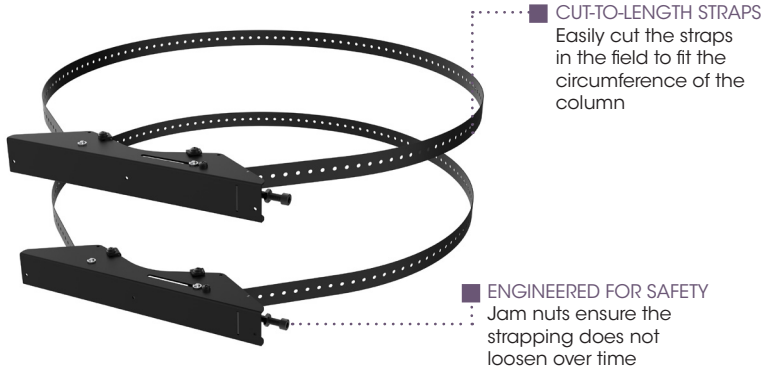

Technical Specifications

Part No.	Max Weight	Compatible Column Size	Compatible Peerless-AV Products
CMAL	102kg (225lb)	200 - 800mm (7.9" to 31.5")	SF16D, SF640(P), SF650(P), SF660(P), SF670(P), SF680(P), ST16D, ST640(P), ST650(P), ST660(P), ST670(P), ST680(P), SP746P, SA740P, SA752PU, SA761PU, SA771PU, SFP680, STP680

I-Beam Mount

For digital signage displays

The perfect solution for securing displays to various sized I-beams, both indoors and outdoors. This product can be used in indoor manufacturing applications looking to create digital dashboards on the production floor to display KPI reporting, Six Sigma initiatives, or even branded content during customer visits. The mount's corrosion resistant design allows for outdoor use in stadiums, arenas, or parking garages with limited wall mounting space.

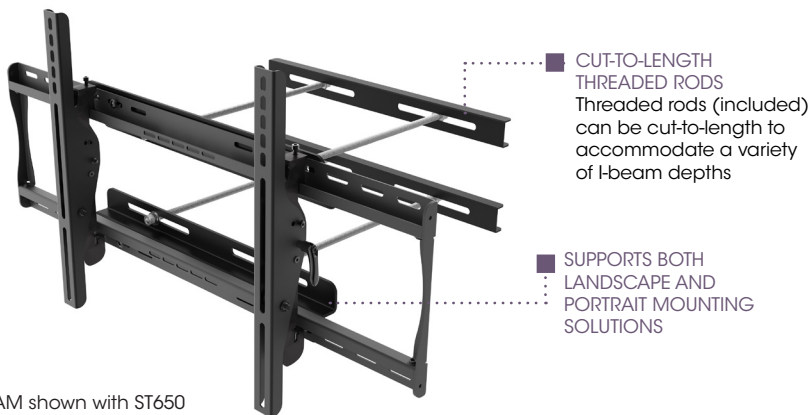

IMAM shown with ST650

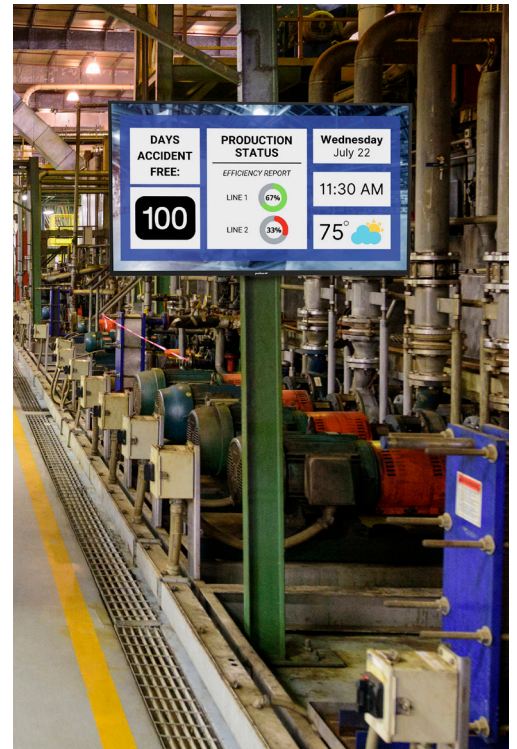

Technical Specifications

Part No.	Max Weight	Compatible Beams	Compatible Peerless-AV Products
IMAM	102kg (225lb)	Up to 12" wide beams	Indoor: SF630, SF632, SF640, SF650, SF660, ST630, ST632, ST640, ST650, ST660, SP746PU, SA730P, SA740P, SA746PU, PF630, PF632, PF640, PF650, PF660, PT630, PT632, PT640, PT650, PT660, PP730P, PP740P, PA730P, PA740P, PA746P
IMAL		For 12" to 24.5" wide beams	Outdoor: EPT640, EPT650, EWMU, ESF655P, EST655P

Media Player Holders

Flat/Tilt Wall Mount with Media Device Storage

- For 40 - 60" Screens
- Compatible with VESA® mounting hole patterns from 200 x 100 up to 400 x 400mm
- ACC-V900X available for 600 x 400mm, 800 x 400mm and 900 x 400mm mounting patterns
- Display can be mounted in portrait or landscape
- Continuous tilt options from 0° to 10° or fixed at 0°, 3.5° and 7°
- Overall size 470 x 436 x 72mm



Model	Internal Storage	Max VESA®	Max Weight	Wall/Ceiling
DST660	305x330x61mm	400x400mm*	57kg	Wall

Flat/Tilt Wall/Ceiling Mount with Media Device Storage

- For 26 - 60" Screens
- Built-in adaptor plate supports VESA® 100x100, 200x100, 200x200 & 300x300mm*
- Universal mounting in either portrait or landscape orientation
- Built-in 360° swivel allows for ideal viewing angle (ceiling mounted)
- Continuous tilt up to 20°
- Overall size 473 x 388 x 109mm

*Adaptor available for larger VESA® patterns



Model	Internal Storage	Max VESA®	Max Weight	Wall/Ceiling
DST360	381x229x76mm	300x300mm*	68kg	Wall & Ceiling

Flat/Tilt Universal Ceiling Mount with Media Device Storage (40-95")

- For 40 - 95" Screens
- Universal mounting in either portrait or landscape orientation
- Accommodates VESA® mounting patterns of 200 x 200, 300 x 300, 400 x 200, 400 x 300 and 400 x 400mm*
- Ratchet style tilt from 0° to 15° simplifies the install
- Overall size 437 x 439 x 97mm
- Rear cover removed for easy access to the media player without having to remove the display

*ACC-V900X adaptor enables 600 x 400mm, 800 x 400mm and 900 x 400mm mounting patterns



Model	Internal Storage	Max VESA®	Max Weight	Wall/Ceiling
DST995	406x279x83mm	400x400mm*	102kg	Ceiling

Media Player Holder Accessory

- For 32 - 60" Screens
- Compatible with a variety of Peerless pivot and articulating wall mounts or independent
- Direct wall mountable option
- VESA® 100 x 100, 200 x 100 and 200 x 200mm compliant*
- Overall size 312 x 310 x 92mm
- Prop-open feature for quick service access without removing the display
- Landscape or portrait display orientation

*PLP compatible for extended mounting patterns



Model	Internal Storage	Max VESA®	Max Weight	Wall/Ceiling
DSX750	254 x 304 x 64mm	200x200mm*	90kg	Wall

Ultra Slim™



The Ultra-Slim range has been specifically designed and developed to complement the very latest ultra thin flat panel screens (measuring 50.8mm/2" max depth). Becoming slimmer all the time, these ultra flat screens require a wall mount that positions the screen as close to the wall as possible.

This is the thinnest complete range of mounting solutions including flat-to-wall, flat locking and fully articulating options that all retain the same low profile design for an almost invisible appearance once mounted, yet all offer exceptional features and functionality.

So make a stunning statement with the most discreet wall mount ever developed for your brand new screen.



Ultra Slim™ Articulating Wall Mounts

Model shown: SUA771PU

■ Up to 13mm (±0.5") of vertical adjustment for post-installation leveling and height adjustment fine-tuning

■ Display roll up to 5° for tool-less post-installation screen levelling

■ Arm retracts to 47mm (1.85") and extends up to 631mm (24.85") from wall

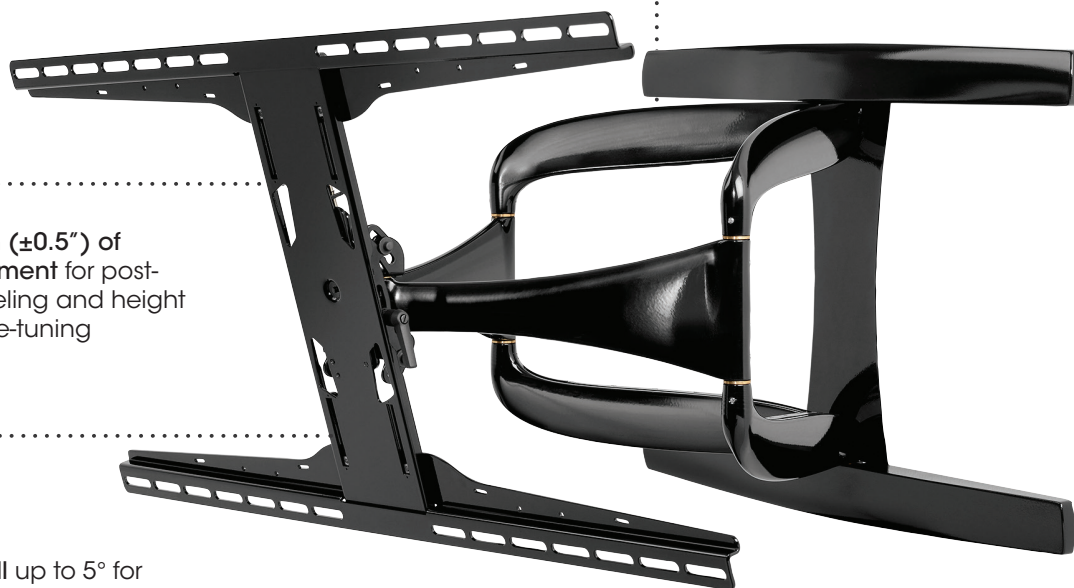

One of the thinnest wall arm mounts on the market, the Peerless-AV® Universal Ultra Slim Articulating Wall Mount is designed exclusively for ultra-thin displays. Featuring a dual-arm construction, the SUA771PU is robust enough to hold larger displays firmly in any position - landscape or portrait - while still offering an ultra-low profile.

An innovative I-shaped adaptor plate makes it easy to access the back of the display, keeping hardware hidden, and features internal cable management, providing a clean, professional look that transitions smoothly from the wall to the display. With a gloss black finish, the SUA771PU matches any décor.

■ Internal cable management provides clean, professional installation finish

■ One-Touch™ tilt mechanism allows adjustment of +15/-5° without the use of tools

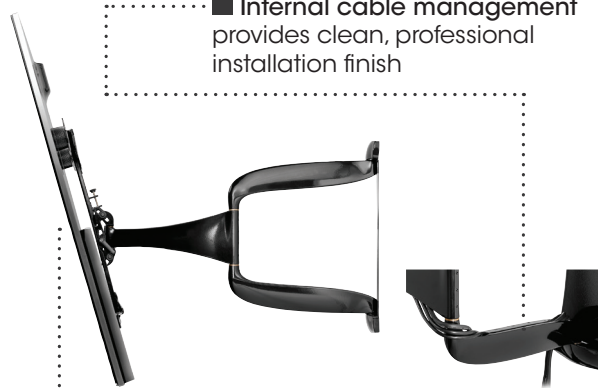

Ultra Slim™ Flat-Locking Mounts

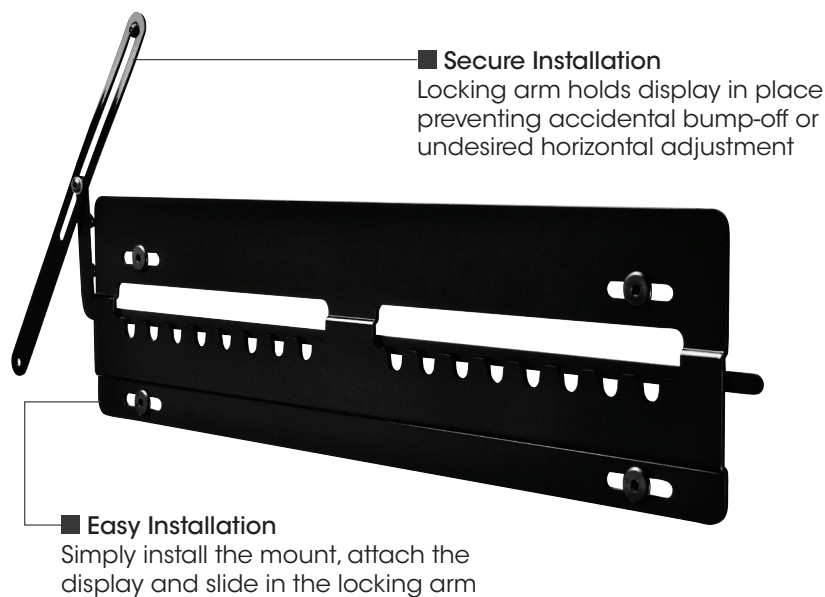

Model shown: SUF641

■ **Ultra Slim Design**
At only 5mm deep, the mount virtually disappears behind the screen

	FLAT	FLAT LOCKING	ARTICULATING SUA740P
MEDIUM Ultra Thin	peerless-AV®	peerless-AV®	 VESAs® 200x100mm, 200
	SUF640P	SUF641	SUA747PU
MEDIUM-LARGE Ultra Thin	 Up to VESAs® 400x400mm	 Up to VESAs® 400mm	 Up to VESAs® 400x400mm
	SUF650P	SUF651	SUA761PU
LARGE Ultra Thin	 Up to VESAs® 600x400mm	 Up to VESAs® 700mm	 Up to VESAs® 600x400mm
	SUF660P	SUF661	SUA771PU
X-LARGE Ultra Thin	 Up to VESAs® 800x400mm	 Up to VESAs® 800mm	 Up to VESAs® 800x400mm

Part No.	Screen sizes	Max. weight	Tilt	Swivel	Roll	Height Adjustment	Distance from wall Closed - Extended	Mounting pattern
SUA740P	32-43"	27kg (60lbs)	+15/-5°	±90°	±5°	±12.7mm (1/2")	44mm - 628mm	VESAs® 200x100mm, 200x200mm
SUF640P	37-50"	68kg (150lbs)	-	-	-	-	8mm	Universal up to 450 x 402mm
SUF641	24-50"	68kg (150lbs)	-	-	-	-	5mm	75 to 425mm (in 25mm increments)
SUA747PU	32-50"	27kg (60lbs)	+15/-5°	±90°	±5°	±12.7mm (1/2")	47mm - 631mm	Universal up to 400 x 400mm
SUF650P	37-75"	68kg (150lbs)	-	-	-	-	8mm	Universal up to 742 x 449mm
SUF651	37-75"	68kg (150lbs)	-	-	-	-	5mm	150 to 700mm (in 25mm increments)
SUA761PU	37-65"	36kg (80lbs)	+15/-5°	±90°	±5°	±12.7mm (1/2")	47mm - 631mm	Universal up to 600 x 400mm
SUF660P	40-80"	68kg (150lbs)	-	-	-	-	8mm	Universal up to 825 x 449mm
SUF661	40-80"	57kg (125lbs)	-	-	-	-	5mm	150 to 800mm (in 25mm increments)
SUA771PU	42-90"	57kg (125lbs)	+15/-5°	±45°	-	±12.7mm (1/2")	47mm - 631mm	Universal up to 800 x 400mm

SMARTMOUNT®



Simply the most versatile and easy to install mounts, yet packed with clever features, SmartMount represents a complete range of LCD, LED and Plasma screen mounts designed to enhance any professional AV installation.

Whether for a pub or club, guestroom, boardroom or classroom, all SmartMount products incorporate intelligent design to add value to a professional AV installation. Many models allow the screen to be displayed in portrait or landscape orientations, ideal for digital signage applications.

SmartMount models are available in a durable black finish to complement today's AV equipment. For the ultimate AV experience – choose SmartMount!

	FLAT	TILT	PIVOT
SMALL 10-29" VESA® 75,100	SF630P 	ST630P 	SA730P
MEDIUM 22-43" VESA® 75,100, 200x100, 200	SF632P 	ST632P 	SA740P
MEDIUM-LARGE 32-50" Up to VESA® 400x400mm	SF640P 	ST640P 	SA746PU
LARGE 39-75" Up to 700x400mm	SF650P 	ST650P 	SA752PU
X-LARGE 39-80" Up to VESA® 800x400mm	SF660P 	ST660P 	SA761PU
XX-LARGE 46-90" Up to 800x400mm	SF670P 	ST670P 	SA771PU
XXX-LARGE 60-98" Up to 1000x600mm	SF680P 	ST680P 	peerless-AV®

ACC918 Security fasteners for mounts with VESA® 75, 100, and 200x100mm mounting patterns

ACC925 Security Fasteners for VESA® 200x200mm up to VESA® 800x400mm mounting patterns



ACC-WMVCs

Video conferencing shelf accessory can be raised or lowered above or below display for perfect positioning. Max load: 6.8kg (15lb)

Compatible with:
Flat-to-Wall: SF640P to SF660P
Tilt: ST640P to ST660P
Articulating: SA752PU to SA771PU



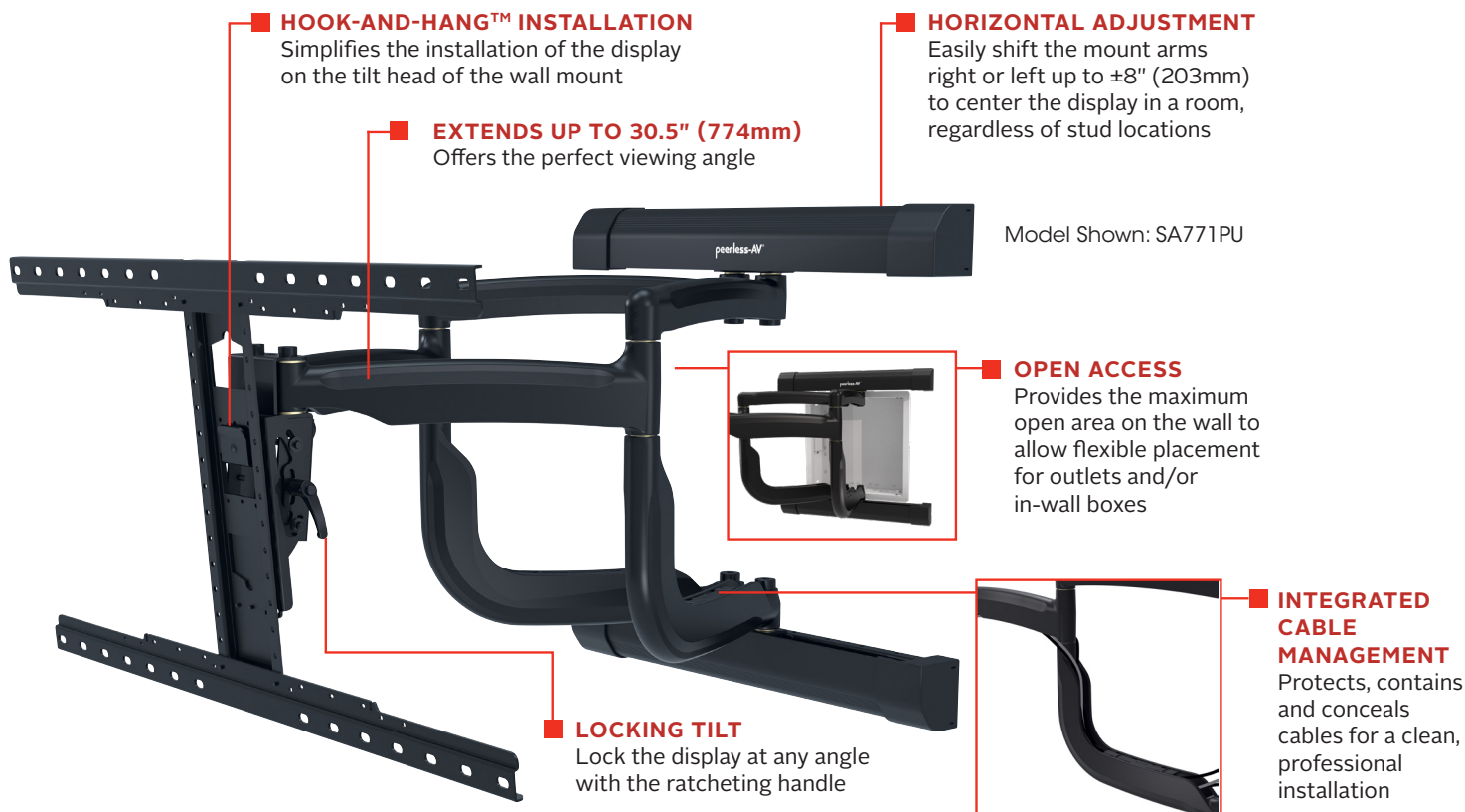

Model Shown: SA771PU



Flat-to-Wall - Portrait SFP680
 Screen Size: 46"-90"
 Max Weight: 158kg (350lbs)
 VESA: up to 400 x 600mm

- Horizontal & Vertical post-install adjust
- Quick removal drawstrings
- Built-in service kickstands



Tilting - Portrait STP680
 Screen Size: 46"-90"
 Max Weight: 158kg (350lbs)
 VESA: up to 400 x 600mm

- Adjustable tilt angle from -5° to 15°
- Horizontal & Vertical post-install adjust
- Quick removal drawstrings
- Built-in service kickstands

Part No.	Screen sizes	Max. weight	Tilt	Swivel	Roll	Height Adjustment	Arm extension	Mounting pattern
SF630P	10-29"+	36kg (80lbs)	-	-	-	-	-	VESA® 75 & 100
ST630P	10-29"+	36kg (80lbs)	+15/-5°	-	-	-	-	VESA® 75 & 100
SA730P	10-29"+	11kg (25lbs)	±35°	±90°	±5°	-	432mm	VESA® 75 & 100
SF632P	22-43"+	52kg (115lbs)	-	-	-	-	-	VESA® 75, 100, 200x100, 200
ST632P	22-43"+	52kg (115lbs)	+15/-5°	-	-	-	-	VESA® 75, 100, 200x100, 200
SA740P	22-43"+	36kg (80lbs)	+15/-5°	±90°	±5°	±12.7mm	554mm	VESA® 100, 200x100, 200
SF640P	32-50"+	68kg (150lbs)	-	-	-	6.3mm	-	Universal up to 400x400mm
ST640P	32-50"+	68kg (150lbs)	+15/-5°	-	-	6.3mm	-	Universal up to 400x400mm
SA746PU	32-50"+	36kg (80lbs)	+15/-5°	±90°	±5°	±12.7mm	564mm	Universal up to 400x400mm
SF650P	39-75"+	79kg (175lbs)	-	-	-	6.3mm	-	Universal up to 742x405mm
ST650P	39-75"+	79kg (175lbs)	+15/-5°	-	-	6.3mm	-	Universal up to 742x405mm
SA752PU	43-65"+	41kg (90lbs)	+15/-5°	±90°	±5°	±12.7mm	672mm	Universal up to 600x400mm
SF660P	39-80"+	91kg (200lbs)	-	-	-	6.3mm	-	Universal up to 824x405mm
ST660P	39-80"+	91kg (200lbs)	+15/-5°	-	-	6.3mm	-	Universal up to 824x405mm
SA761PU	43-75"+	68kg (150lbs)	+15/-5°	±90°	±5°	±12.7mm	676mm	Universal up to 600x400mm
SF670P	46-90"+	113kg (250lbs)	-	-	-	6.3mm	-	Universal up to 895x450mm
ST670P	46-90"+	113kg (250lbs)	+15/-5°	-	-	6.3mm	-	Universal up to 895x450mm
SA771PU	50-90"+	90.7kg (200lbs)	+15/-5°	±90°	±5°	±12.7mm	676mm	Universal up to 800x400mm
SFP680	46-90"+	158kg (350lbs)	-	-	-	-	-	Universal up to 494x650mm
STP680	46-90"+	158kg (350lbs)	+15/-5°	-	-	-	-	Universal up to 455x650mm
SF680P	60-98"+	158kg (350lbs)	-	-	-	6.3mm	-	Universal up to 1100x650mm
ST680P	60-98"+	158kg (350lbs)	+15/-5°	-	-	6.3mm	-	Universal up to 1061x650mm

PARAMOUNT™



With Paramount by Peerless-AV, selecting the perfect mount for your screen has never been easier—and installation is even more straightforward!

Engineered for quick, intuitive setup by professional installers, all Paramount products feature a sleek high-gloss black finish that beautifully complements modern LCD and LED screens. If you're looking for a durable and dependable wall mount, the extensive Paramount range is the ideal solution.



HOOK-AND-HANG INSTALLATION

Display is easily installed by a single person

FLEXIBLE MOUNTING LOCATIONS

Mounts to wood stud, concrete, cinder or breeze block

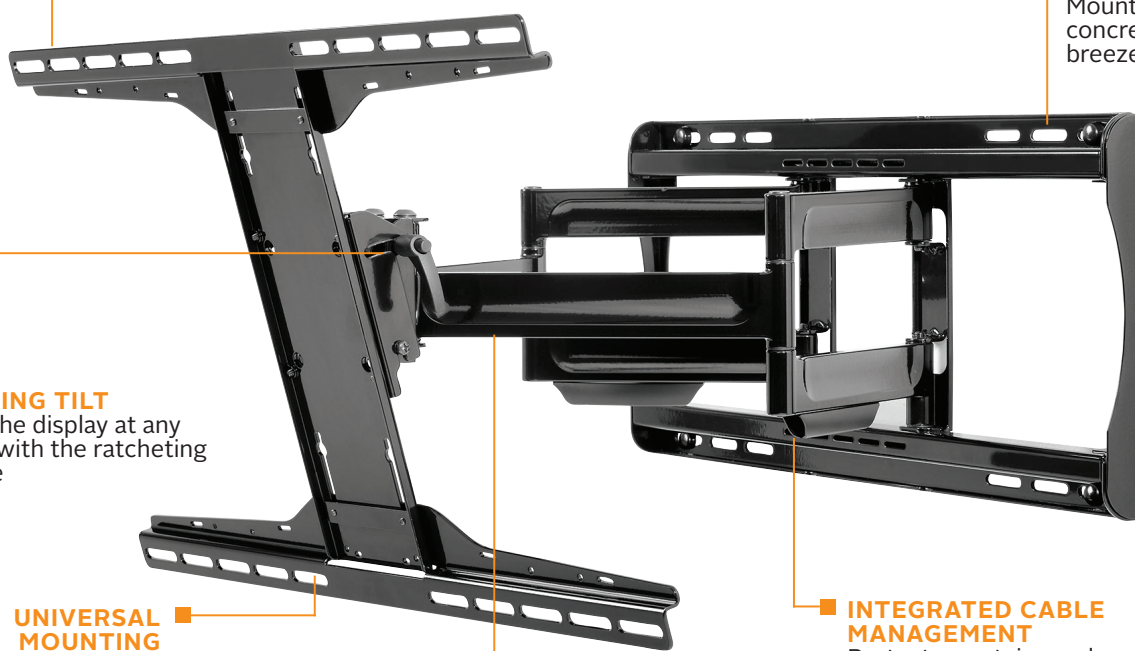

LOCKING TILT

Lock the display at any angle with the ratcheting handle

UNIVERSAL MOUNTING

Accommodates a variety of display mounting patterns

EXTENDS UP TO 542mm

Offers the perfect viewing angle

INTEGRATED CABLE MANAGEMENT

Protects, contains and conceals cables for a clean, professional installation

Recommended Accessories

ACC918

Security fasteners for mounts with VESA® 75, 100, and 200x100mm mounting patterns

ACC925

Security Fasteners for VESA® 200x200mm up to VESA® 800x400mm mounting patterns





















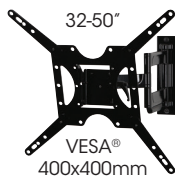

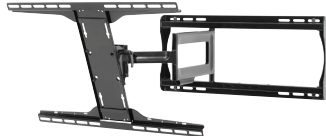

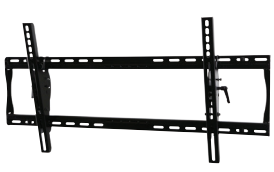



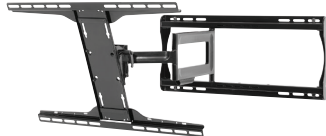

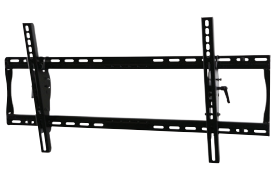
ACC-WMVCS

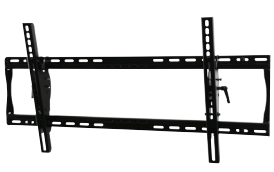
Video conferencing shelf accessory can be raised or lowered above or below display for perfect positioning. Max load: 6.8kg (15lb)

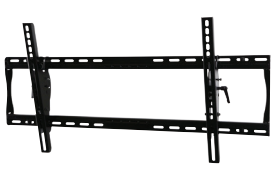
Compatible with:
Flat-to-Wall: PF640 to PF660
Tilt: PT640 to PT660
Articulating: PA750 & PA762

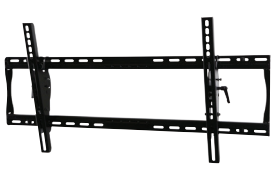

	FLAT	TILT	PIVOT	ARTICULATING
SMALL 10-29" VESA® 75/100	PF630 	PT630 	PP730 	PA730 
	PF632 	PT632 	PP740 	PA740 
MEDIUM 22-43" VESA® 200x200	PF640 	PT640 	peerless-AV®	PA746  32-50° VESA® 400x400mm
	PF650 	PT650 		PA750 
LARGE 32-46" Up to VESA® 400x300mm	PF660 	PT660 	PA762  Up to VESA® 600x400mm	
	PF650 	PT650 	PA750 	
X- LARGE 39-75" Up to VESA® 600x400mm	PF660 	PT660 	PA762  Up to VESA® 600x400mm	
	PF660 	PT660 	PA762  Up to VESA® 600x400mm	
XX-LARGE 39-90" Up to VESA® 800X400mm	PF660 	PT660 	PA762  Up to VESA® 600x400mm	
	PF660 	PT660 	PA762  Up to VESA® 600x400mm	

Part No.	Screen sizes	Max. weight	Tilt	Swivel	Roll	Arm extension	Mounting pattern
PF630	10-29"	23kg (50lbs)	-	-	-	-	VESA® 75, 100
PT630	10-29"	23kg (50lbs)	+15/-5°	-	-	-	VESA® 75, 100
PP730	10-29"	11kg (25lbs)	±15°	±90°	±5°	188mm	VESA® 75, 100
PA730	10-29"	11kg (25lbs)	±15°	±90°	±5°	377mm	VESA® 75, 100
PF632	22-43"	36kg (80lbs)	-	-	-	-	VESA® 75, 100, 200x100, 200
PT632	22-43"	36kg (80lbs)	+15/-5°	-	-	-	VESA® 75, 100, 200x100, 200
PP740	22-43"	36kg (80lbs)	+15/-5°	±90°	±7°	207mm	VESA® 100, 200x100, 200
PA740	22-43"	36kg (80lbs)	+15/-5°	±90°	±7°	379mm	VESA® 100, 200x100, 200
PF640	32-46"	45kg (100lbs)	-	-	-	-	Universal up to 450x305mm
PT640	32-46"	45kg (100lbs)	+15/-5°	-	-	-	Universal up to 450x305mm
PA746	32-50"	36kg (80lbs)	+15/-5°	90°	±5°	383mm	VESA® up to 400x400mm
PF650	39-75"	68kg (150lbs)	-	-	-	-	Universal up to 742x405mm
PT650	39-75"	68kg (150lbs)	+15/-5°	-	-	-	Universal up to 750x405mm
PA750	39-75"	45kg (100lbs)	+15/-5°	90°	±5°	542mm	Up to VESA® 600x400mm
PF660	39-90"	91kg (200lbs)	-	-	-	-	Universal up to 825x405mm
PT660	39-90"	91kg (200lbs)	+15/-5°	-	-	-	Universal up to 832x405mm
PA762	39-90"	68kg (150lbs)	±15°	±90°	±5°	542mm	Up to VESA® 600x400mm



SMARTMOUNT® Universal Scissor Wall Mount for 39" to 120"+ Displays

Peerless-AV's SmartMount® Universal Scissor Wall Mount is the optimal mounting solution for UC/VC applications and recessed walls as the STS models allow for convenient access to components stored behind the display. Available as standard depth model (STS650) and Ultra-Slim solution (STS680) that positions the display as close as 44mm from the wall for the most discreet install.

- Display extension up to 324mm allows for post-installation servicing and access to the screen rear, while closed mount depth can be adjusted and locked to provide space for component storage behind display
- Universal mount fits displays with mounting patterns from 200 x 100 up to 600 x 600mm (STS650) & 1000 x 600mm (STS680)
- Adjustable up to 15° of forward tilt for the desired viewing angle, with optional IncreLok™ feature providing a range of preset tilt settings
- Menu board style wall plate with open frame design (compatible with IB14X9-W In-Wall Box)
- Automatic spring locks with quick release cords. Simplify the installation and removal of the display
- Up to 12mm of post-installation leveling with side-to-side adjustability to fine tune the mounted display for perfect positioning
- Center keyhole for easy leveling and installation
- Optional Accessory: Universal AV Component Mount (STS650: ACC-UCM2 STS650 / STS680: ACC-UCM3) allows components to be installed, configured and cabled off-site, and quickly attaches to the mount which reduces on-site installation time
- STS680 compatible with the Crestron® Flex UC Brackets with ACC-STSCF1 accessory



STS650 Shown with (2) optional ACC-UCM2 Universal AV Component Mounts

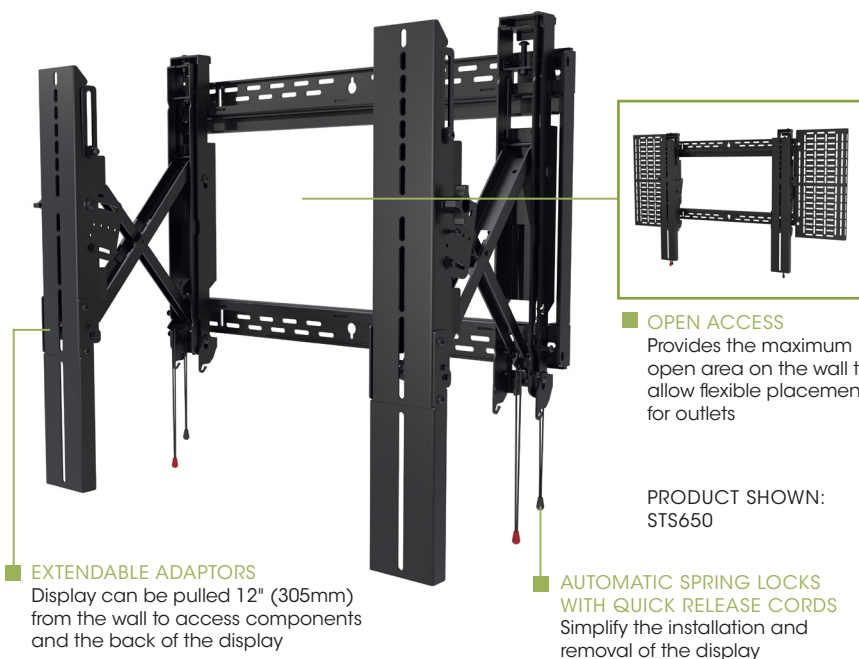

Technical Specifications

Part No.	Screen Size	Max. weight	Mounting pattern
STS650	39 - 85" +	90kg (200lb)	200 x 100 to 600 x 600mm
STS680	49 - 120" +	114kg (250lb)	200 x 100 to 1000 x 600mm

Lockable Wall Mounts

Peerless-AV's Security Locking Mounts offer the next level of security within the wall mount range with a secure locking bar and provided padlock. With 3 size ranges in flat-to-wall, tilting and portrait mountable solutions, this line provides a high level of theft deterrence for 22" to 75" screens in public areas where security is of higher concern.

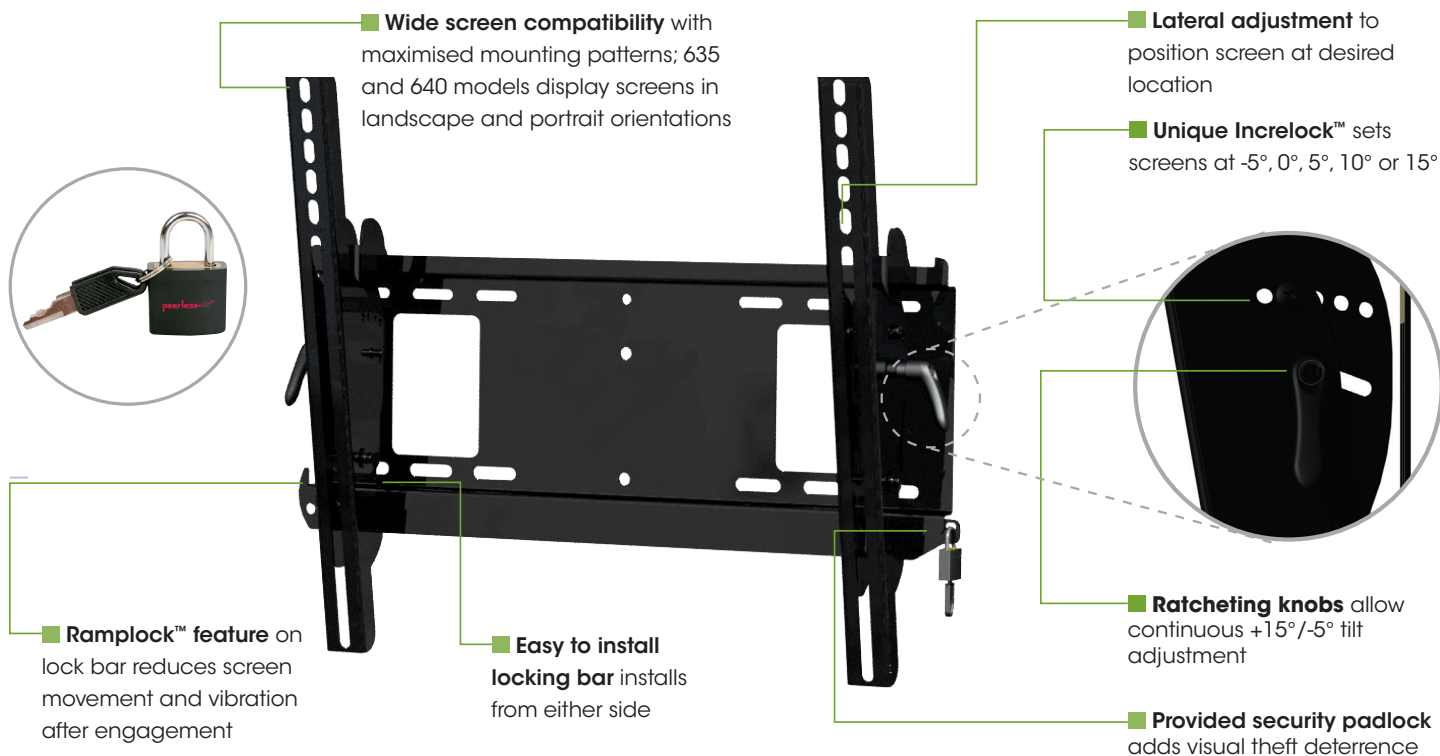

Technical Specifications				
Part No.	Screen Size	Orientation	Max Load	Mounting pattern
PFL635	22"-43"	Landscape / Portrait	56kg (125lbs)	Up to VESA® 200x200mm
PTL635	22"-43"	Landscape / Portrait	56kg (125lbs)	Up to VESA® 200x200mm
PFL640	32"-60"	Landscape / Portrait	68kg (150lbs)	Up to VESA® 400x400mm
PTL640	32"-60"	Landscape / Portrait	68kg (150lbs)	Up to VESA® 400x400mm
PFL650	37"-75"	Landscape	79kg (175lbs)	Up to VESA® 700x400mm
PTL650	37"-75"	Landscape	79kg (175lbs)	Up to VESA® 700x400mm
PFL650	37"-75"	Portrait	68kg (150lbs)	Up to VESA® 400x700mm
PTL650	37"-75"	Portrait	68kg (150lbs)	Up to VESA® 400x700mm

Pull-out Swivel Wall Mounts

- Ideal product for digital signage and hospitality applications where screen must be recessed
- Arms extend up to 271mm (10.68") from wall
- Pull-out swivel with up to 90° rotation (±45° left or right)
- 0, 5 or 10° lockable tilt
- Pull-out swivel with up to 90° rotation (±45° left or right)
- Integrated cable management
- ±1° roll for horizontal screen alignment during installation
- Locking tab included for optional swivel restriction to one side



Model shown: SP850-UNL

Technical Specifications				
Part No.	Screen Size	Colour	Max. weight	Mounting pattern
SP850	32-80"	Black	68kg (150lbs)	VESA® 100, 200 x 100mm*
SP850-UNL	32-80"	Black	68kg (150lbs)	Universal up to 700 x 400mm

Hospitality Universal Swing Out Wall Mount

- Up to 90 degrees of swing out provides multiple viewing angles and quick maintenance access
- Wall plate and hinge covers create an aesthetically appealing look
- Integrated cable management protects, contains and conceals cables for a clean, professional installation
- Designed to swing open to the left or right for adaptable room placement
- Easily installs on 16" or 24"



Technical Specifications			
Part No.	Screen Size	Max. weight	Mounting pattern
HPF675	55-75"	36kg	200 x 200 to 400 x 400mm

Hospitality Wall Arm Mount

- Covers can easily be removed for serviceability to STB/cable box without the need to remove arm or TV
- The I-Shaped Adaptor plate's innovative design helps avoid blocking connections on back of display
- Can be installed on wall or recessed into wall for a discreet appearance
- $\pm 90^\circ$ of pivot left or right, up to 5° downward tilt (HA746-STB)
- Built-in swivel up to $\pm 30^\circ$ (HPF650)
- Landscape or portrait mounting increases display versatility

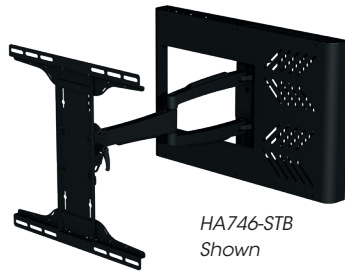

HA746-STB
Shown

Technical Specifications			
Part No.	Screen Size	Max. weight	Mounting pattern
HA746-STB	43-55"	36kg (80lb)	Up to VESA® 400 x 400mm
HPF650	32-55"	27kg (60lbs)	Up to VESA® 400 x 400mm

Articulating Mount with In-Wall Box

- Up to $\pm 90^\circ$ of side-to-side swivel
- Added $\pm 5^\circ$ of roll for post-installation display leveling without the use of tools
- Up to $\pm 0.5"$ (13mm) of vertical adjustment for post-installation leveling and height adjustment fine-tuning
- Landscape or portrait mounting options increases display versatility
- Installs between 406mm (16") stud centers, to a single stud, or directly into a drywall opening
- Knock-outs for 3/4", 1.0", 1.25" and 1.5" conduit
- Cut-Out Dimensions: 365 x 365mm (14.4" x 14.4")

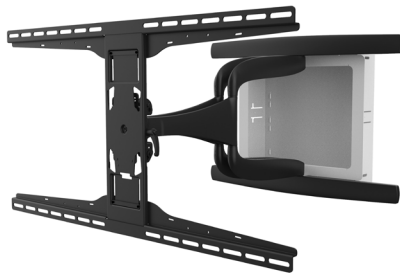

Technical Specifications			
Part No.	Screen Size	Max. weight	VESA®
IM771PU	42" - 90" Ultra Thin Displays	Mount: 56.7kg In-Wall Box: 11.3kg	800 x 400mm VESA® adaptors

In-Wall Box Mounting Plate for Securing Devices inside In-Wall Boxes

The IBMP is a flexible mounting solution for small AV components that need to be hidden. This can be attached to various Peerless-AV® In-Wall Boxes and mounting solutions.

- Easily stacks multiple pieces of AV equipment
- Can be used to bundle excess cable to prevent cable droop over time
- Multiple openings allow components to be bolted or cable tied into place
- Can be mounted horizontally or vertically in the 14 x 14" In-Wall Boxes
- The IBMP is easily installed or removed with just one screw

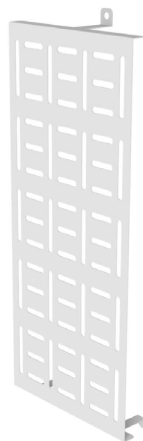

Technical Specifications		
Part No.	Colour	Max. Weight
IBMP	White	2.27kg

In-Wall Box for AV Components

- Installs between 406mm (16") stud centers, to a single stud or directly into a drywall opening
- Knock-outs for 3/4" (19mm), 1.0" (25.4mm), 1.25" (31.7mm) and 1.5" (38.1mm) conduit
- Adjustable trim ring allows use of 3/8" (9.5mm) - 3/4" (19mm) drywall thickness
- Drywall clamps allow the In-Wall Box to be installed in drywall, unsupported by studs
- Modular mounting plates. Removable top and bottom plates ease installation by allowing wiring terminations to take place outside of the box



IB14X9-W
Shown

Technical Specifications			
Part No.	Cut-Out Dims	Colour	Max. weight
IB14X9-W	365 x 238mm (14.4" x 9.4")	White	11.3kg (25lb) 4.5kg (10lb) (drywall only)
IB14X14-W	365 x 365mm (14.4" x 14.4")		25lb (11.3kg) 10lb (4.5kg) (drywall only)

Articulating Mount with In-Wall Box

- Up to $\pm 90^\circ$ of side-to-side swivel
- Added $\pm 5^\circ$ of roll for post-installation display leveling without the use of tools
- Up to $\pm 0.5"$ (13mm) of vertical adjustment for post-installation leveling and height adjustment fine-tuning
- Landscape or portrait mounting options increases display versatility
- Installs between 406mm (16") stud centers, to a single stud, or directly into a drywall opening
- Knock-outs for 3/4", 1.0", 1.25" and 1.5" conduit
- Cut-Out Dimensions: 365 x 365mm (14.4" x 14.4")
- Obstruction free in-wall box provides ample room and accessibility to equipment

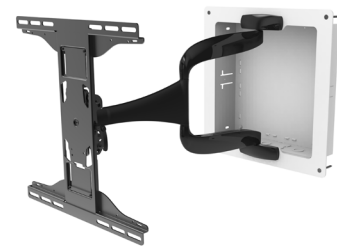

Technical Specifications			
Part No.	Screen Size	Max. weight	VESA®
IM747PU	37" - 65" Ultra Thin Displays	Mount: 36.3kg In-Wall Box: 11.3kg	400 x 400mm VESA® adaptors

Recessed Storage Accessory Box

- Low-profile design fits behind the thinnest mounts and flat panel displays
- Component cables routed inside the wall
- Sleek design makes outside cable covers unnecessary
- Cable ties and grommet included for an organised finish
- Heavy gage cold rolled steel construction



IBA3 Shown

Technical Specifications		
Model	Dimensions (w x h x d)	Colour
IBA3	442 x 146 x 96mm	Gloss Black White (IBA3-W)
IBA4-W	82 x 124 x 55mm	White

Universal UC/VC Soundbar Mount

- Universal UC/VC Soundbar mount compatible with Soundbars with suitable fixing points
- Designed for use with large displays:
Single Display: 55" to 98"+
Dual Displays: 55" to 75"
- Weight capacity 9kg
- Mount the sound bar above or below the display(s)
- Compatible with Peerless-AV® Flat, Tilt and Articulating Wall Mounts, Trolleys, and Stands
- Fully adjustable. Achieve perfect placement of the sound bar relative to the display(s)

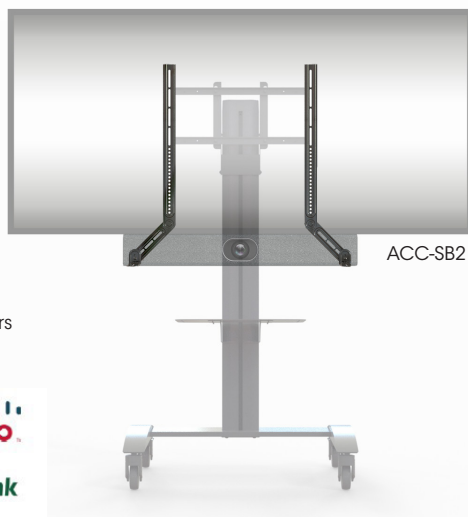

ACC-SB2

Compatible with all UC/VC Soundbars & Videobars including the following brands:



Single AV Wall Unit with Glass Shelf



ACC200

ACC300

- Strong, tempered glass shelf
- Durable aluminium shelf bracket can be adjusted to accommodate AV components of any height
- Cable management system helps keep cables concealed and organized
- Supports up to 13kg (30lbs) per shelf
- Included spirit level enables a quick and easy install

Universal AV Component Mount

- Supports AV components up to 2kg
- Low profile design, creates an aesthetically appealing look
- Can be mounted to various wall surfaces, Peerless-AV products, or directly to the TV's VESA® pattern
- Includes (2) anti-scratch pads to cushion the device while it is held in place
- Includes hardware to easily attach to Peerless-AV® wall mounts

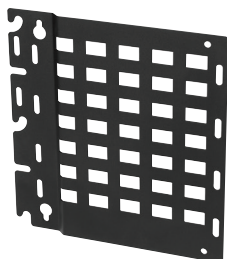

Technical Specifications		
Part No.	Max Weight	Dimensions
ACC-UCM	2kg (5lb)	213 x 222 x 9mm

Universal AV Component Mount

- Specifically designed for the STS650
- Includes (1) Universal Component Plate
- Supports AV components up to 4.5kg
- Includes (4) anti-scratch pads to cushion the device while it is held in place
- Includes (6) hook and loop ties to secure the component mount
- Hook-and-hang™ installation, Easily attaches to the left or right side of the STS650

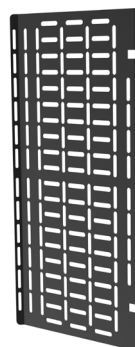

Technical Specifications		
Part No.	Max Weight	Dimensions
ACC-UCM2	4.5kg (10lb)	238 x 25 x 508mm



Solstice Pod Mount

- Dedicated to the Mersive Solstice Pod
- Wall, table and service rack mountable for added versatility
- Low profile design, mounting just 34mm in depth ensures a discreet installation
- Compatible with nano Kensington Lock for additional security
- Easy access for servicing
- Anti tamper design

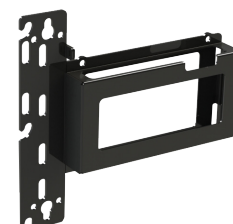

Technical Specifications	
Part No.	Dimensions
ACC-MSP	220 x 242.7 x 34mm

Universal Adaptor Plates



PLP-UNL Shown

* Check website for latest models & availability

Model	Screen Size	Weight	VESA® Pattern
PLP-UNM	22-50"	68kg	400x400mm
PLP-UNL	32-90"	68kg	600x400mm

Dedicated Adaptor Plates

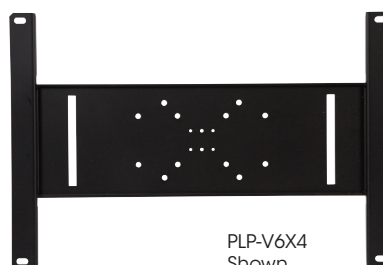

PLP-V6X4 Shown

Model	VESA® Pattern	Model	VESA® Pattern
PLP-V100	100x100mm	PLP-V4X3	400x300mm
PLP-V2X1	200x100mm	PLP-V4X4	400x400mm
PLP-V2X2	200x200mm	PLP-V6X2	600x200mm
PLP-V3X2	300x200mm	PLP-V6X4	600x400mm
PLP-V3X3	300x300mm	PLP-V6X6	600x600mm
PLP-V4X2	400x200mm	PLP-V8X4	800x400mm
		PLP-V9X6	900x600mm

Accessory Adaptor Rails and Mounting Extenders

Model	Max Weight	Mounting pattern
ACC-V1500X	91kg	Convert 400mm or 500mm mounting pattern to 1000mm, 1200mm or 1500mm
ACC-V600800	57kg	Convert 400 x 400 to 600 x 400 and 600 x 400 to 800 x 400mm
ACC-V600X	59kg	Convert 400 x 400 to 600 x 400mm
ACC-V900X	68kg	Convert 400mm and 500mm width/height to 600mm, 800mm or 900mm width/height
ACC2X1	11kg	Increases the mounting pattern of 75 & 100mm mounts to include 200 x 100mm
ACC4X4	32kg	Increases mounting pattern of 200 x 200mm mounts to include 300 x 200, 300 x 300, 400 x 300, and 400 x 400mm

Trolleys & Stands



Peerless-AV's sleek and stylish trolleys and stands are designed to provide the ideal display viewing position and match the décor of any environment - boardrooms, training rooms, lobbies, classrooms, auditoriums or exhibition halls. A full line-up of accessories allows each stand to be tailored to meet specific requirements - whether video conferencing in a boardroom or presenting on a trade show floor.

All models boast internal cable management to conceal all unsightly wires for a clean appearance and have the option of theft-deterrent screen mounting hardware for added security in public areas. Features of specific models include the ability to add extra adaptors to mount additional screens (either stacked or back-to-back) and height adjustment along the main column length. This versatile and adaptable range is the ideal solution to all your free standing and mobile AV & VC requirements.

SMARTMOUNT® Flat Panel Trolleys for 43" to 110"+ Displays

- Improved leg design offers better movement around the display, such as when using a touch display or presenting to an audience
- Tube design and spacing creates flexible handling locations for transporting a display
- 810 x 270mm fixed shelf provides a convenient place to set laptops, notebooks, pens, etc.
- Optional ACC-UCM can be added to the rear of the trolley for mounting of additional AV devices
- 4" (102mm) dual wheeled casters meet UL specifications and allow the trolley to easily move across tile, carpet and across thresholds
- Integrated IEC Cable for a clean and simple installation



REMOVABLE REAR COVER
Sits behind the rear of the display and provides a clean, concealed area for managing cabling and components (Shelf is made of ABS plastic; materials do not degrade WiFi signals)



HIDDEN CABLE MANAGEMENT
Hinged rear cover provides hidden storage for the power cable when moving or storing the trolley

HEIGHT ADJUSTMENT
Allows displays to be positioned 1250 to 1660mm from the floor (at time of install)



The frame design of the trolley is optimised for storing multiple trolleys in a reduced footprint



The leg design allows the trolley to easily pass through doorways as small as 762mm wide



Model shown: SR860-EUK

Technical Specifications

Part No.	Screen Size	Max. weight	Colour	Mounting pattern
SR860-EUK	43" to 75"	56kg	Black	200 x 200 up to 800 x 400mm
SR898-EUK	55" to 110"+	136kg		200 x 200 up to 900 x 600mm

SMARTMOUNT. Trolley for 32" to 75" Displays

- Includes a three-piece base and pre-assembled adaptor plate to reduce packaging waste and carton size
- Three-piece base also provides rigidity, stability, and quick assembly
- Vertical adjustment, display and optional component shelf can be located anywhere along the column (up to 60" at center)
- 5 degrees of negative adjustment keeps even the heaviest of displays level
- Pre-assembled open frame adaptor helps prevent display input interference
- Integrated cable management protects, contains and conceals cables for a clean, professional installation
- Textured black powder coat finish helps hide finger prints and dust
- Universal display adaptor fits mounting patterns from 200 x 200mm to 600 x 400mm and allows mounting in landscape or portrait orientation
- Trolley includes (4) plastic base pads for instances when casters are not needed



Technical Specifications			
Part No.	Screen Size	Max. weight	Mounting pattern
SR560M	32"-75"	68kg (150lbs)	from 200 x 200mm to 600 x 400mm

SMARTMOUNT. Large Format Trolley for 55" to 98"+ Displays

- Includes a three-piece base to reduce packaging waste and carton size
- Three-piece base also provides rigidity, stability, and quick assembly
- Display can be located anywhere along the column for perfect viewing height up to 1.5m (60") at centre
- Up to 5° of negative tilt keeps even the largest displays level
- Integrated cable management protects and conceals cables for a clean, professional installation
- Manoeuvres easily on 4" (102mm) swivel casters, two locking
- Textured black powder coat finish helps hide finger prints and dust
- White version also available (SR598W)



Technical Specifications				
Part No.	Screen Size	Max. weight	Colour	Mounting pattern
SR598	55"-98"+	136kg	Black	Up to VESA® 900x600mm
SR598W			White	

SMARTMOUNT. VC Trolley for two 40" to 65" Displays

- Displays can be located anywhere along the column for perfect viewing height up to 1.5m (60") at centre
- Up to 5° of negative tilt keeps the display level
- Integrated cable management protects and conceals cables for a clean, professional installation
- Camera mount and equipment shelf are adjustable for versatile positioning
- Manoeuvres easily on 4" (102mm) swivel casters, two locking
- Fully welded base provides rigidity, stability and quick assembly
- Textured black powder coat finish helps to hide finger prints and dust



Technical Specifications			
Part No.	Screen Size	Max. weight	Mounting pattern
SR555M	40"-65"	34kg per display	Up to VESA® 600x400mm

SMARTMOUNT. Trolley for 32" to 75" Displays

- Tool-less height adjustment of 500mm places the centre of the display anywhere from 1m to 1.5m
- Up to 5° of negative tilt keeps the display level
- Integrated cable management protects and conceals cables for a clean, professional installation
- Manoeuvres easily on 4" (102mm) swivel casters, two locking
- Pre-assembled base provides rigidity and quick assembly
- Corner bumpers protect wall and doorways from damage
- Textured black powder coat finish helps to hide finger prints and dust



Technical Specifications			
Part No.	Screen Size	Max. weight	Mounting pattern
SR575M	32"-75"	68kg (150lbs)	Up to VESA® 600x400mm

PARAMOUNT™ Flat Panel Trolley for 55" to 75"+ Displays

The Peerless-AV® Paramount™ Flat Panel Trolley provides a sleek mobile solution for 55" to 75"+ displays. This trolley is built with two heavy-duty poles that perfectly center the display. The shape of the base allows multiple trolleys to be nested together, reducing the amount of storage space needed. The PR565 also comes with a spacious metal shelf for AV components, as well as a video conferencing camera that can be mounted above or below the display.

- Universal mount fits displays with mounting patterns from 200 x 200mm up to 1000 x 600mm
- 39.7" (1008mm) W x 8.5" (215mm) D fixed steel component shelf holds up to 20lb (9.1kg)
- Smooth black powder coat finish helps to hide finger prints and dust
- Display can be positioned 45.2"-61.5" (1147-1563mm) from the floor in 5.5" (140mm) increments
- Video conferencing camera shelf, mounts above or below the display and fits most displays up to 98"
- Base shape is designed to nest multiple trolleys together, reducing the amount of storage space needed
- Video conferencing shelf is height adjustable and has a max load rating of 10lb (4.5kg)

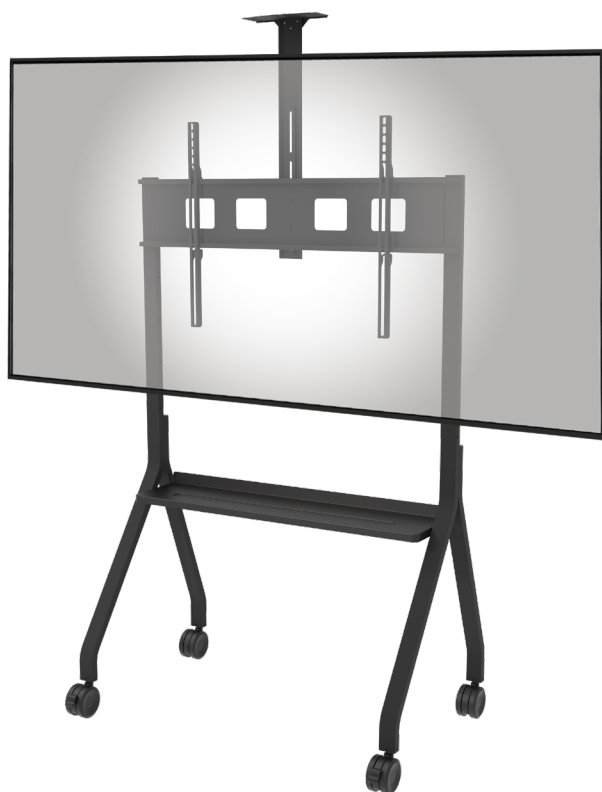

Technical Specifications

Part No.	Screen Size	Max. weight	Mounting pattern
PR565	55" - 75"+	68kg (150lb)	200 x 200 up to 1000 x 600mm

PARAMOUNT™ Motorised Trolley for 50" to 98" Displays

- Centre of display adjusts by 500mm from 1m to 1.5m from the floor
- Digital display indicates the height of the centre of display and includes four preset settings that can be saved for future use
- Added security screws lock adapters to backplate
- Includes shelf for media equipment which can be installed front or rear of the trolley for convenience
- Includes pressure sensor making it an ideal solution for education where safety is paramount
- Textured black powder coat finish helps hide finger prints and dust



Easy to program height settings via digital display



Technical Specifications

Part No.	Screen Size	Max. weight	Colour	Mounting pattern
PR598-M	50" to 98"+	130kg (286lb) display 4kg (8.8lb) media shelf	Black	100 x 100 up to 800 x 600mm



PARAMOUNT™

Motorised Height Adjustable Trolley
for 50" to 95"+ Displays

NEW

The Peerless-AV® Paramount™ Motorised Height Adjustable Trolley is designed to safely mount, move, and store an interactive display. Integrated actuators allow you to raise or lower a display, up to 250mm, with the touch of a button. The durable grey powder coat finish provides a nice aesthetic to complement this highly functional solution that is ideal for any touchscreen application.

- Robust, cold-rolled steel frame, along with a heavy-duty motor and actuators, allows the trolley to handle the heaviest displays, up to 90.7kg
- Integrated digital controls at the rear of the trolley allow users to raise, lower, or lock the movement of the display with no remotes to lose or batteries to replace
- Pre-assembled casters expedite installation
- Textured grey powder coat finish helps hide fingerprints and dust
- Includes 3m power cord

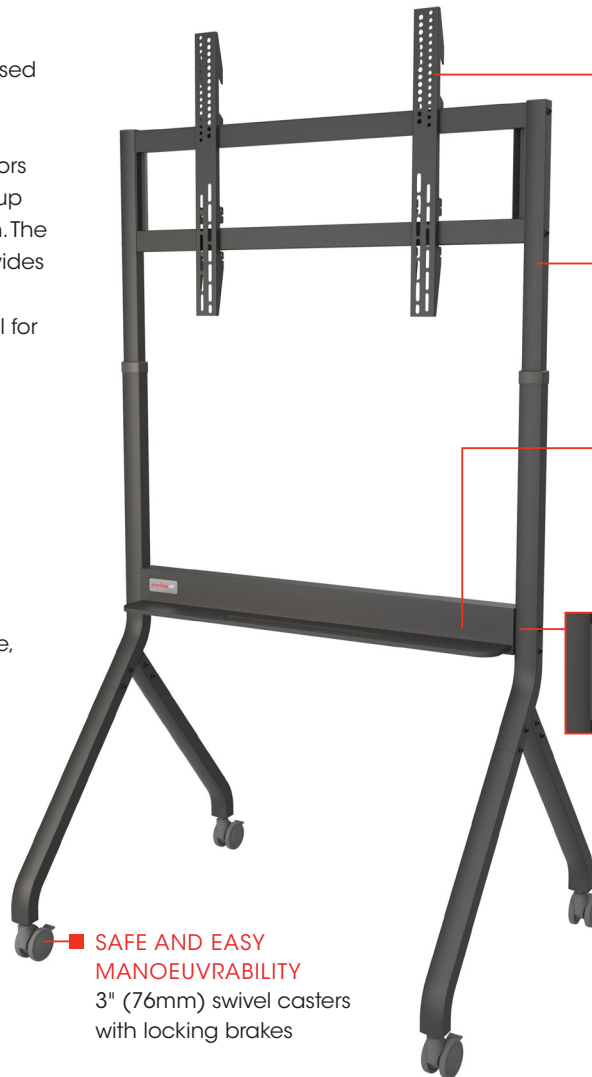

- **UNIVERSAL VESA® PATTERN**
Fits a variety of displays with mounting patterns ranging from 200 x 200 to 900 x 600mm
- **VERTICAL ADJUSTMENT**
Center of display adjusts from 1500 to 1750mm from the floor with the touch of a button
- **INTEGRATED SHELF**
Store everyday items, such as a digital pen, mouse or laser pointer on the 963 x 99mm integrated shelf
- **UNIVERSAL RECEPTACLE**
The universal receptacle on the rear of the trolley provides easy-access power for the display

- **SAFE AND EASY MANOEUVRABILITY**
3" (76mm) swivel casters with locking brakes

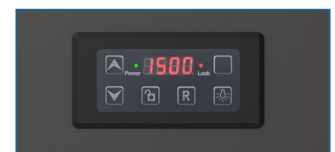

Integrated digital controls at the rear of the trolley

Technical Specifications

Part No.	Screen Size	Max. weight	Colour	Mounting pattern
PR565ML3-EUK	50" to 95"+	90.7kg (200lb) Display	Grey	200 x 200 up to 900 x 600mm

Mobile Trolley with Rotational Interface for the 55" and 65" Samsung Flip



- Display can be located anywhere along the column for perfect viewing height (up to 1.5m at screen centre) **at time of install*
- Interface smoothly rotates the display from landscape to portrait while providing the stability for a touch display
- Rotational interface holds the display at a 0° or -4.5° to further promote ergonomics and a more natural writing surface
- Cable management access provides routing options on both sides of the mount for power and data
- Manoeuvres easily on 4" (102mm) swivel casters, two locking. Also includes 4 plastic base pads when casters are not needed
- Pre-assembled base provides rigidity, stability and quick assembly
- Gloss white, powder coat finish closely matches the finish of the Samsung Flip
- 400 x 400 VESA® and custom length M8 hardware provide the proper mounting for the Samsung Flip



Also available as a Rotational Wall Mount
RMI3-FLIP2

Technical Specifications

Part No.	Solution	Screen Size	Max. weight	Rotation	Colour	Mounting pattern
SR560-FLIP2	Trolley	55" or 65" Samsung Flip	41kg	90°	Gloss White	400 x 400mm
RMI3-FLIP2	Wall Mount					

Mobile Trolley for the 50.5" Microsoft® Surface™ Hub 2S & 3



- Display can be located vertically along the column 1219 - 1524mm from the floor, adjusted in 76mm (3") increments **at time of install*
- Display can be mounted in landscape or portrait orientation **at time of install*
- Dedicated mount fits the Microsoft® Surface™ Hub 350 x 350mm mounting pattern and includes the proper depth mounting bolts
- Set your display at a -4.5° ergonomic tilt for natural writing or 0° tilt for standard interaction
- Open frame adaptor, provides necessary clearances for I/O ports and removable compute cartridge
- Open storage area for cables and other components provided (508mm x 207mm)
- Internal cable management protects, contains and conceals cables for a clean, professional installation
- Flat white powder coat finish complements the finish of the Microsoft® Surface™ Hub



Also available as a Wall Mount
SF640-HUB2

UPS Mounting Brackets for attaching the APC CSH2 to the SR560-HUB2
ACC-CSH2

Technical Specifications

Part No.	Solution	Screen Size	Colour
SR560-HUB2	Trolley	50.5" Microsoft® Surface™ Hub 2S and 3	White
SF640-HUB2	Wall Mount		White
SR598-HUB2	Trolley	85" Microsoft® Surface™ Hub 2S and 3	Black
SF680P-HUB2	Wall Mount		Black

VC Solution for two 55" to 80" Displays

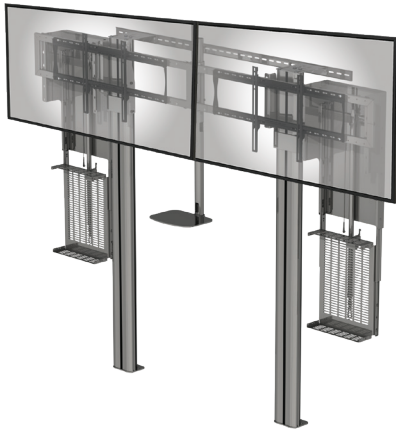

- Cables run discreetly through the uprights for a clean, clutter free appearance
- Flexible design secures to both a raised floor and concrete floor
- Vertical micro-adjustment. Post installation leveling and display alignment
- Set the display height anywhere along the column for the perfect viewing angle
- Height adjustable camera shelf provides flexibility when mounting larger displays or adjusting the viewing angle
- Two 2RU rack storage units conveniently drop below the display for service

Technical Specifications

Part No.	Screen Size	Max. weight	Mounting pattern
VCM580	2 x 55-80"	152kg (335lbs)	Up to 600x400mm

Kiosk Stand for 32" to 75" Displays



- Capable of +90° tilt from horizontal to vertical plane for kiosk and interactive applications
- Secure media player storage below the display with simple access to the device without having to remove the display
- Cables can enter and exit on either side anywhere along the column and are held in place with a high tech polymer cover
- Base provides secure foundation for touch applications
- Textured black powder coat finish helps hide finger prints and dust

Technical Specifications

Part No.	Screen Size	Max. weight	Mounting pattern
SS575K	32-75"	68kg (150lbs)	Up to VESA® 600x400mm

Floor Stand for 32" to 75" Displays



- Display can be located anywhere along the column for perfect component placement and viewing height up to 1.5m (60") at centre
- 5° of negative tilt keeps the display level
- Integrated cable management protects and conceals cables for a clean, professional installation
- Wide base provides safety by preventing accidental tipping
- Textured black powder coat finish helps hide finger prints and dust
- Open frame display adaptor helps prevent display input interference

Technical Specifications

Part No.	Screen Size	Max. weight	Mounting pattern
SS560F	32-75"	68kg (150lbs)	Up to VESA® 600x400mm

Floor Stand for Back-to-Back Displays



- Display adaptor for single or back-to-back mounting up to VESA 200x200mm
- Larger hole patterns require additional PLP adaptor
- Continuous display height adjustment on 1.8m column for perfect viewing height
- Media player enclosure in base (FPZ-670 model)
- Integrated cable management for clean and tidy appearance
- Portrait or Landscape display orientation

Technical Specifications

Part No.	Screen Size	Max. weight	Mounting pattern
FPZ-670	Up to 90"	90kg per display	Up to VESA® 200x200mm
FPZ-600	Up to 70"	90kg per display	Up to VESA® 200x200mm

Trolley and Stand Accessories

ACC-MS

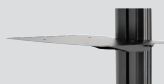

Metal Shelf for SR Trolleys & SS Stands
Max. weight 4.5kg (10lb) per shelf

ACC-LA

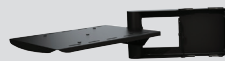

Metal Laptop Shelf for SR Trolleys & SS stands
Max. weight 4.5kg (10lb) per shelf

ACC-VCS



Video Conferencing Shelf for Trolleys & stands
Max. weight: 2.3kg (5lb) per shelf

ACC-SB2



Universal UC/VC Soundbar mount compatible with Soundbars with suitable fixing points

ACC979



SmartMount SR Trolley Caster Accessory Kit
Set of (4) swivel casters with (2) locking and (2) non-locking

ACC310



Adjustable foot for SmartMount Trolleys and Stands
Allows ½" of adjustment for uneven floors

ACC-MSF-W



Rear Metal Shelf for SR560-FLIP2 mobile Trolley
Max. weight 4.5kg (10lb) per shelf

ACC116



Rear Metal Shelf for SR560-HUB2 mobile Trolley
Max. weight 4.5kg (10lb) per shelf

ACC-CSH2



UPS Mounting Brackets for Mounting the APC CSH2 to the Peerless-AV® SR560-HUB2

Twin Pole Modular Series

Flat Panel Screen Mount System



Large AV installations can be an involved and time-consuming business. Peerless-AV believes that bigger - both in terms of screen size or the number of displays - does not have to mean more complicated. Constantly striving to improve the versatility and ease of use of our products by working closely with installers and integrators, the Twin Pole Modular Series product range is designed to ensure the very best installer experience.

Designed around twin 50mm columns, the components in this series can be combined to fulfil multiple requirements, from a single ceiling mounted display to an unlimited floor-to-ceiling video wall array. With a minimal number of SKUs and a simple, intuitive method of selecting the required parts, it could not be simpler to create the bespoke Modular Series arrangement that is ideally suited to your next project.

For peace of mind all Modular Series products are tested to the highest UL mounting safety standards to withstand four times the rated load capacity. A number of innovative features, such as incremental tilt and back-to-back screen options, that benefit the end user and make them the most versatile and easy to install products available.

TWIN POLE DESIGN ■ ensures a sturdy and secure mounting foundation with each system able to accommodate up to 192kg

UNIVERSAL MOUNTING ■ for flat panel displays from 46" to 90", up to VESA® 600x400mm (adaptors available for other mounting hole patterns)

BACK-TO-BACK ■ option for simple and effective creation of a double sided display from a single system

PORTRAIT / LANDSCAPE ■ orientation with versatility to mount both ways from a single screen adaptor or with specific video wall options

FIXING KITS SUPPLIED ■ for screen attachment, with security options available for displays in public areas

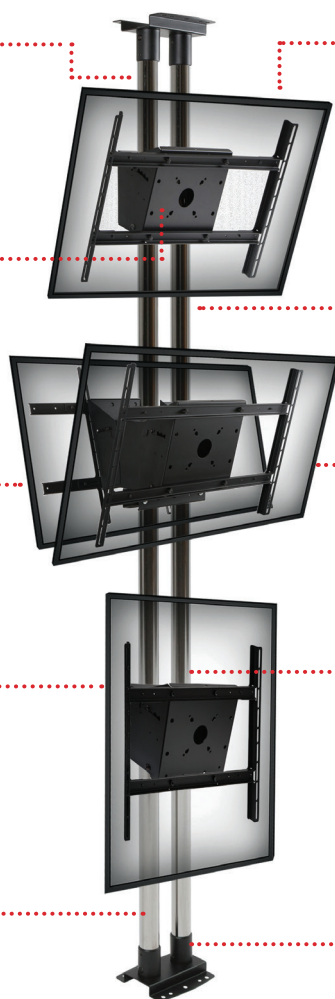

MULTIPLE DISPLAYS ■ can be mounted onto each system, and can be positioned anywhere along the column length

ANY LENGTH ■ can be achieved with poles cuttable to shorter length and ability to extend by connecting multiple units

DURABLE FINISH ■ with powder coated black parts and zinc plated silver finish which prevent rusting and resists scratches and chips

TILT ADJUSTMENT ■ from +20° to -5°, with specific settings at 5° increments, for perfect and consistent viewing angle

MODERN AESTHETICS ■ for a clean appearance with base plate covers and cable management ability within the poles

Twin Pole Modular Series

Choose Your Design

There are two ways to configure your Modular Series solution, depending upon your specific requirements. This can be in either a single twin column application with one or more displays on an individual unit, or with a number of twin column units and multiple screens on each combined to form a video wall application.

Single Application



One twin pole system, available in 4 different mounting options, with single or multiple displays arranged in portrait, landscape or back-to-back orientation using MOD-UNL2 screen adaptor.

Video Wall Application



Combination of multiple twin pole systems, available in 3 different mounting options, with multiple displays arranged in portrait or landscape orientation using standard screen adaptor or dedicated video wall mounts.

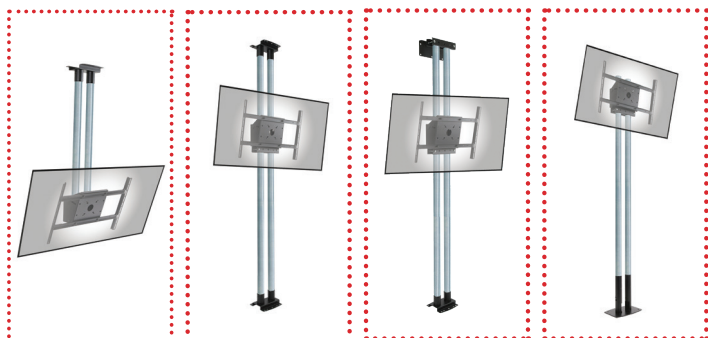

- 1 Ceiling Mount System
- 2 Floor to Ceiling Mount System
- 3 Floor to Wall Mount System
- 4 Floor Mounted System

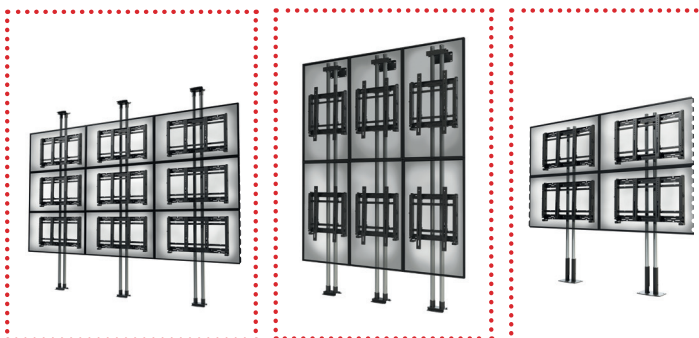

- 1 Floor to Ceiling Video Wall Mount System
- 2 Floor to Wall Video Wall Mount System
- 3 Floor Mounted Video Wall System

Twin Pole Modular Series Configurator

Our Modular Series Configurator is an online tool designed to revolutionise the way mounts are selected. This tool simplifies the specifying process and gives users a comprehensive, streamlined process for designing and building their ideal twin pole unit or twin pole video wall.

Detailed information and specifications on products and accessories is shown once clicked on and the tool's future proof data engine ensures that information is always up to date.

Visit peerless-av.com/pages/modular-series-configurator to get your project started!

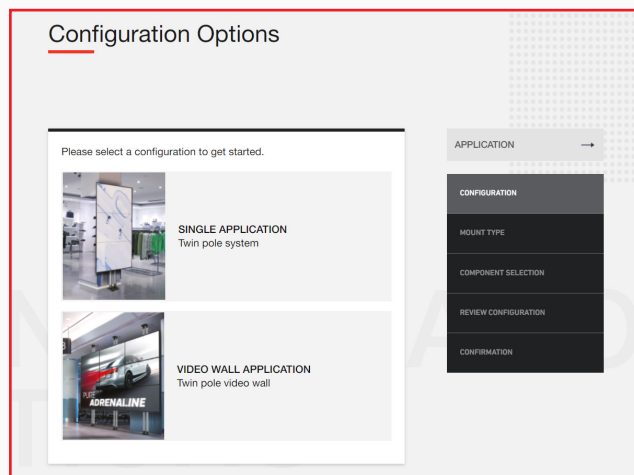

Floor to Wall System



VESA® up to 600x400mm



Max weight 96kg per display 192kg total @ 3m length

When space is limited create an eye-catching visual display against a wall or in a totem arrangement aligned to a column or pillar. The MOD-WP2 wall bracket positions each screen a mere 172mm from the wall for a discrete appearance and includes fine adjustment of ± 22 mm to enable a simple way to ensure columns are installed vertically.

COMPONENTS REQUIRED FOR EXAMPLE SHOWN



MOD-FPMS2
Single Screen Mount Bracket

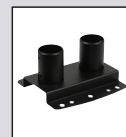

MOD-CPF2
Heavy Duty Floor/Ceiling Plate



MOD-ASC2
Screen Stacking Clamp



MOD-P200
2m Zinc Plated Silver Pole

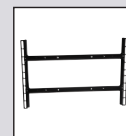

MOD-UNL2
Universal Screen Adaptor



MOD-WP2
Wall Mount Attachment

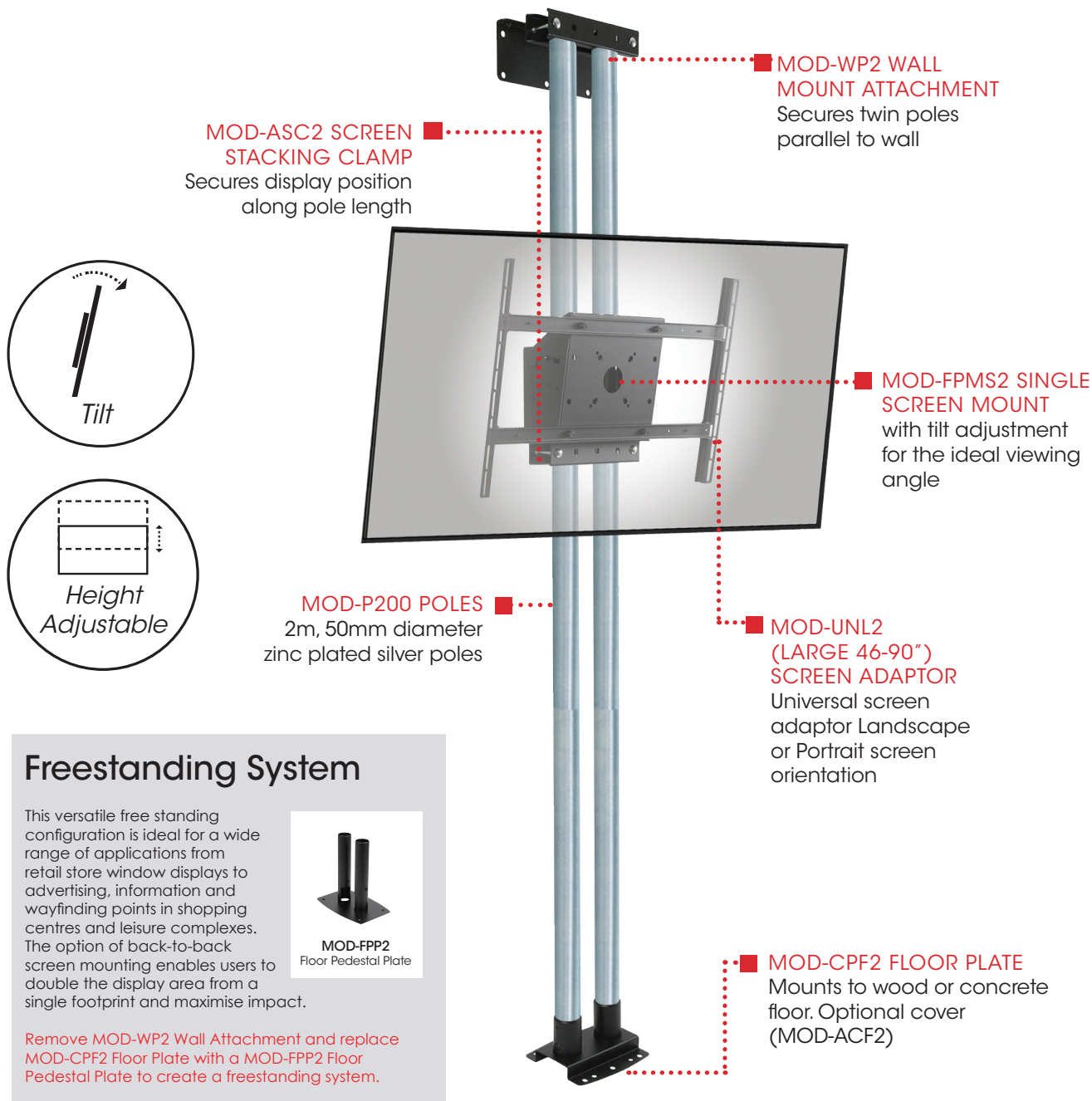

Freestanding System

This versatile free standing configuration is ideal for a wide range of applications from retail store window displays to advertising, information and wayfinding points in shopping centres and leisure complexes. The option of back-to-back screen mounting enables users to double the display area from a single footprint and maximise impact.



MOD-FPP2
Floor Pedestal Plate

Remove MOD-WP2 Wall Attachment and replace MOD-CPF2 Floor Plate with a MOD-FPP2 Floor Pedestal Plate to create a freestanding system.

Configure Your Bespoke Twin Pole Display Solution

By Selecting Required Components in 5 Simple Stages

1 Choose the ceiling / wall / floor plate

	Heavy Duty Ceiling/Floor Plate MOD-CPF2 Mounts to concrete & wood joist ceilings Max Weight: 192kg (422lbs)
	Ceiling Plate Cover MOD-ACF2 Cover for MOD-CPF2 ceiling/floor plate
	Wall Plate MOD-WP2 Adjustment: +/- 22.2mm
	I-Beam Ceiling Plate MOD-CPI2 Fully adjustable for I-beams 85mm to 250mm wide Tilt: +/- 60° Max Weight: 192kg (422lbs)
	Floor Pedestal Plate MOD-FPP2 Floor mounting applications bolts in place for added security Max Weight: 192kg (422lbs)

2 Select the pole length & accessories

	Extension Poles MOD-P100 1.0m (39") length, MOD-P150 1.5m (59") length, MOD-P200 2.0m (78") length, MOD-P300 3.0m (118") length
	Tube End Cap Kit MOD-ACAP (Black) Kit contains 2pcs Provides clean pole end finish
	Trim Disc MOD-ATD-W (White) Fits around pole to clean up rough cut through false ceiling tiles
	Pole Coupler MOD-APC Connects 2 x 50mm diameter poles
	Pole Drill Fixture MOD-ADF (Black) Allows marking & positioning of new installation holes to be drilled into newly cut 50mm diameter poles

3 Screen configuration adaptor

	Screen-Stacking Clamp MOD-ASC2 (Black) Clamps around extension pole to stack multiple screens Max: weight 96kg (211lb)
	Single Screen Mount MOD-FPMS2 Tilt Angle: +20/ -5° VESA®: 75/100/200 x 200mm Max weight: 96kg (211lb)
	Back-to-Back Screen Mount MOD-FPMD2 Tilt Angle: +20/ -5° VESA®: 75/100/200 x 200mm Max weight: 192kg (411lb)

4 Required screen mount/media box

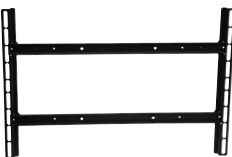
	Universal Screen Adaptor MOD-UNL2 Screen Size: 46" - 90" Max VESA®: 600 x 400mm Max Weight: 96kg (211lb)
--	---

5 Optional

	Media Box Holder MOD-MBM (MOD-FPMS2 only) Max weight: 4.55kg (10lb) Max internal dimensions: 195 x 195 x 35mm
	Media Box Holder MOD-MBL (MOD-FPMS2 only) Max weight: <i>Contact Sales</i> Max internal dimensions: 254 x 304 x 64mm

Floor to Ceiling Video Wall System



VESA® up to 700x400mm

Max weight 57kg per display 192kg total @ 2m length

The ultimate solution for creating a large format video wall, where the only limitation is the distance from floor to ceiling. Add multiple screens onto each twin pole system and quickly position the displays with perfect alignment when using the Video Wall mount adaptors, with horizontal movement and 8-point micro adjustment for the ultimate fine tuning.

COMPONENTS REQUIRED FOR EXAMPLE SHOWN

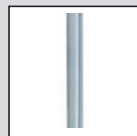

6x MOD-P300 3m Zinc Plated Silver Pole



9x MOD-AWM2 Video Wall Mount Adaptor



9x DS-VW765-LQR Video Wall Mount



6x MOD-CPF2 Heavy Duty Floor/ Ceiling Plate

Example: DS-VW765-LQR

MICRO-ADJUSTMENT
8-point tool-less fine tuning ensures seamless display alignment

DS-VW765-LAND HORIZONTAL SHIFT
Lateral adjustment for flush display alignment

DS-VW765-LQR
Landscape Quick Release mount for flat panel displays from 46" to 65"

DS-VW765-LQR QUICK RELEASE
Simple push release with full extension for simple access & maintenance

MOD-P300 POLES
3m 50mm diameter zinc plated silver poles

MOD-AWM2
Video Wall mount adaptor can be positioned at any point along the columns

MOD-CPF2 FLOOR / CEILING PLATE
Mounts to wood or concrete - Optional cover (MOD-ACF2)



Gentle press to release

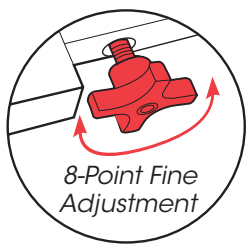

8-Point Fine Adjustment

Freestanding System

This versatile free standing configuration is a fast and effective method to create an eye-catching video wall array in a wide range of applications and settings. When deployed for use in public spaces safety and security are assured with the ability to bolt the floor plate in place and the use of security screen attachment hardware fixings.



MOD-FPP2 Floor Pedestal Plate





Swap out the MOD-CPF2 Floor Plates for MOD-FPP2 Floor Pedestal Plates to create a freestanding video wall system.

Configure Your Bespoke Twin Pole Video Wall Solution By Selecting Required Components in 4 Simple Stages

1 Choose the ceiling / wall / floor plate

	Heavy Duty Ceiling/Floor Plate MOD-CPF2 Mounts to concrete & wood joist ceilings Max Weight: 192kg (422lbs)
	Ceiling Plate Cover MOD-ACF2 Cover for MOD-CPF2 ceiling/floor plate
	Wall Plate MOD-WP2 Adjustment: +/- 22.2mm
	I-Beam Ceiling Plate MOD-CPI2 Fully adjustable for I-beams 85mm to 250mm wide Tilt: +/- 60° Max Weight: 192kg (422lbs)
	Floor Pedestal Plate MOD-FPP2 Floor mounting applications bolts in place for added security Max Weight: 192kg (422lbs)





2 Choose the ceiling / wall / floor plate

	Extension Poles MOD-P100 1.0m (39") length, MOD-P150 1.5m (59") length, MOD-P200 2.0m (78") length, MOD-P300 3.0m (118") length
	Tube End Cap Kit MOD-ACAP (Black) Kit contains 2pcs Provides clean pole end finish
	Trim Disc MOD-ATD-W (White) Fits around pole to clean up rough cut through false ceiling tiles
	Pole Coupler MOD-APC Connects 2 x 50mm diameter poles
	Pole Drill Fixture MOD-ADF (Black) Allows marking & positioning of new installation holes to be drilled into newly cut 50mm diameter poles

3 Screen configuration adaptor

	Wall Mount Adapter MOD-AWM2 Video Wall mount adaptor can be positioned at any point along the columns
---	--

4 Required screen mount/media box

	Landscape Video Wall Mount with Quick Release DS-VW765-LQR Full service mount with quick release. Screen Size: 46-65", Max Weight: 57kg, VESA pattern: Up to 700x400mm
	Landscape Video Wall Mount DS-VW765-LAND Full service mount with pull-out function Screen Size: 40-65", Max Weight: 57kg, VESA pattern: Up to 700x400mm
	Supreme Video Wall Mount DS-VW775 Full service mount with pull-out function Screen Size: 46-60", Max Weight: 57kg, VESA pattern: Up to 600x400mm
	Supreme Video Wall Mount With Quick Release DS-VW775-QR Full service mount with quick release Screen Size: 46-60", Max Weight: 57kg, VESA pattern: Up to 600x400mm

Twin Pole Modular Series Configurator

Create a system that is perfect for your requirements with our Modular Series Configurator. This online tool is designed to give users a comprehensive, streamlined and simple process for designing and building their ideal twin pole unit or twin pole video wall.

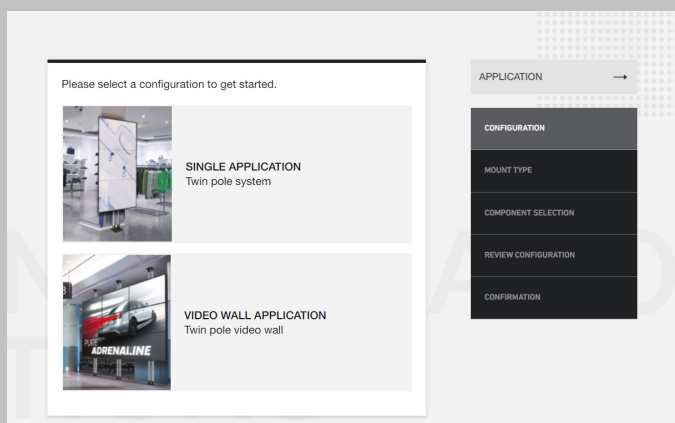

Visit the 'Design Tools' section at www.peerless-av.com for more information

Modular Series Flat Panel Screen Kits



Peerless-AV constantly strives to improve the versatility and ease of use of our products and having listened to the feedback from installers and integrators, it is apparent that the market requires a product range that can fulfil multiple requirements from a limited number of SKUs. Thus the Modular Series has been introduced as a universal ceiling mount solution with around twenty components in the range.

Developed particularly for professional AV applications the Modular System is designed in the UK and manufactured from the same high quality materials as all Peerless-AV mounts for the assurance of durability. For peace of mind, all products are tested to the highest UL safety standards and include a number of innovative features and benefits specific to flat panel mounting, such as fixed tilt and multiple screen options, making them the most versatile and easy to install products available.

MOD-FPSKITxxx/-B MOD-FPSKITxxx-CPF

Flat panel ceiling mount kits

MOD-FPSKITxxx includes:

- 1 x MOD-CPC
- 1 x MOD-Pxxx **
- 1 x MOD-FPMS
- 1 x MOD-UNL

MOD-FPSKITxxx-CPF includes:

- 1 x MOD-CPF
- 1 x MOD-Pxxx **
- 1 x MOD-FPMS
- 1 x MOD-UNL

** Pole part number depends on drop length required

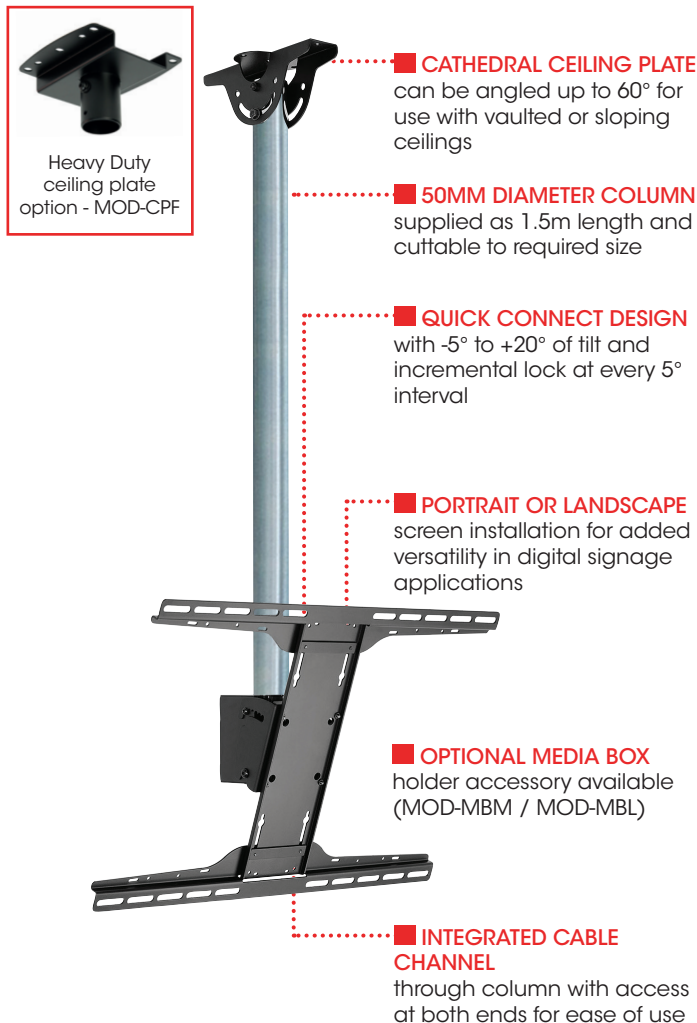

MOD-FCSKIT300

3m floor-to-ceiling mount kit

MOD-FCSKIT300 includes:

- 2 x MOD-CPF: Heavy duty flat ceiling/floor plate
- 1 x MOD-P300: 3.0m zinc plated extension pole
- 1 x MOD-ASC: Screen stacking clamp
- 1 x MOD-FPMS: Single screen mount
- 1 x MOD-UNL: Large universal adaptor

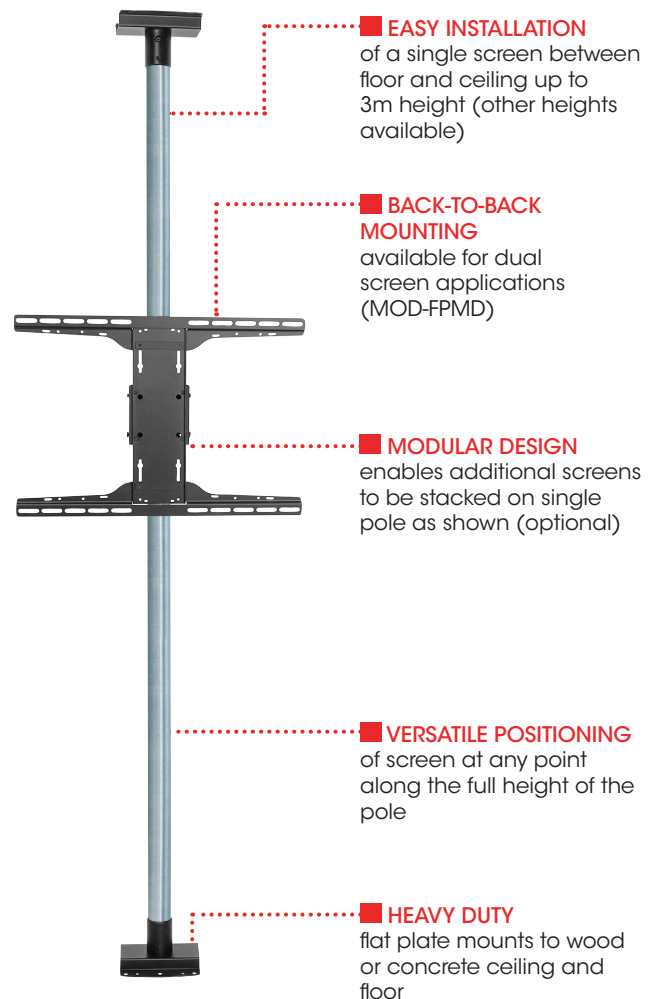





Configure Your Bespoke Solution in 4 Simple Stages

1 Choose the ceiling / wall / floor plate

	<p>Heavy Duty Ceiling/Floor Plate MOD-CPF (Black) MOD-CPF-W (White) Mounts to concrete & wood joist ceilings Max Weight: 170kg (374lbs)</p>
	<p>Ceiling Plate Cover MOD-ACF (Black) MOD-ACF-W (White) Cover for MOD-CPF ceiling/floor plate</p>
	<p>Cathedral Ceiling Plate MOD-CPC (Black) MOD-CPC-W (White) Mounts to concrete & wood joist ceilings Tilt: +/- 60° Max Weight: 120kg (264lbs)</p>
	<p>I-Beam Ceiling Plate MOD-CPI (Black) Fully adjustable for I-beams 85mm to 250mm wide Tilt: +/- 60° Max Weight: 120kg (264lbs)</p>
	<p>U-Bolt Accessory Kit MOD-AUB (Black) Clamps around 40mm to 85mm (1.5-3.3") diameter pipes, trusses etc. Adapts to MOD-CPC & MOD-CPF Max Weight: 120kg (264lbs)</p>







2 Choose the ceiling / wall / floor plate

	<p>Extension Poles MOD-P100 1.0m (39") MOD-P150 1.5m (59") MOD-P200 2.0m (78") MOD-P300 3.0m (118") Also available in White (add '-W' to Part No.) and Black (add '-B' to Part No.)</p>
	<p>Trim Disc MOD-ATD-W (White) Fits around 50mm pole to clean up rough cut through false ceiling tile</p>
	<p>Pole Coupler MOD-APC Connects 2 x 50mm poles</p>
	<p>Pole Drill Fixture MOD-ADF (Black) Allows marking and positioning of new installation holes to be drilled into newly cut 50mm poles</p>

3 Screen configuration adaptor

	<p>Single Screen Mount MOD-FPMS (Black) MOD-FPMS-W (White) Screen Size: 10" to 65" (depending on screen adaptor) VESA® Pattern: 75/100 compliant Max Weight: 100kg (220lbs) Tilt: +20/-5° Swivel: 360°</p>
	<p>Back-to-Back Screen Mount MOD-FPMD (Black) MOD-FPMD-W (White) Screen Size: 10" to 65" (depending on screen adaptor) VESA® Pattern: 75/100 compliant Max Weight: 170kg (374lbs) Tilt: +20/-5° Swivel: 360°</p>
	<p>Screen-Stacking Clamp MOD-ASC (Black) MOD-ASC-W (White) Clamps around extension pole to stack multiple single or dual back-to-back screens Max Load: 85kg (187lbs)</p>

4 Required screen mount/media box

	<p>Large Universal Adaptor MOD-UNL Screen Size: 32" - 75" flat panel screens VESA® Pattern: Up to 600x400 (WxH) Max Weight: 68 kg (150lbs)</p>
	<p>Medium Universal Adaptor MOD-UNM Screen Size: 22" - 50" LCD screens VESA® Pattern: Up to 400x400 (WxH) Max Weight: 68 kg (150lbs)</p>
	<p>Media Box Holder MOD-MBM (MOD-FPMS Only) Media Player Mounting Accessory For Mini Computer and AC Power Adaptor</p>
	<p>Media Box Holder MOD-MBL (MOD-FPMS Only) Media player holder accessory for use with MOD-FPMS modular single screen mount</p>
	<p>VESA 200x100 Adaptor ACC-V2x1 Screen Size: up to 26" VESA Pattern: 200x100 Max Weight: 30kg (66lbs)</p>
	<p>VESA 200x200 Adaptor ACC-V2x2 Screen Size: Up to 22" - 40" VESA Pattern: 200x200, 200x100 Max Weight: 52kg (115lbs)</p>

Kits - Part No.	Convenient Single Box Solutions
MOD-FPSKIT100	Single display, 1m ceiling kit, cathedral ceiling plate
MOD-FPSKIT150	Single display, 1.5m ceiling kit, cathedral ceiling plate
MOD-FPSKIT200	Single display, 2m ceiling kit, cathedral ceiling plate
MOD-FPSKIT100-CPF	Single display, 1m ceiling kit, flat ceiling plate
MOD-FPSKIT150-CPF	Single display, 1.5m ceiling kit, flat ceiling plate
MOD-FPSKIT200-CPF	Single display, 2m ceiling kit, flat ceiling plate
MOD-FCSKIT300	Single display, 3m floor-to-ceiling kit, flat ceiling plate

Xtreme™ Performs Beyond Expectations



There has never been an outdoor daylight readable display built to withstand the harsh outdoor elements like the Peerless-AV® Xtreme™ High Bright Outdoor Displays. With unmatched capabilities, Xtreme High Bright Outdoor Displays are the perfect digital signage or entertainment solution for any professional application. Offering top-of-the-line outdoor video quality, along with the durability & longevity backed by a two-year warranty,

Peerless-AV's award winning Xtreme™ High Bright Outdoor Displays will take your business to the next level.

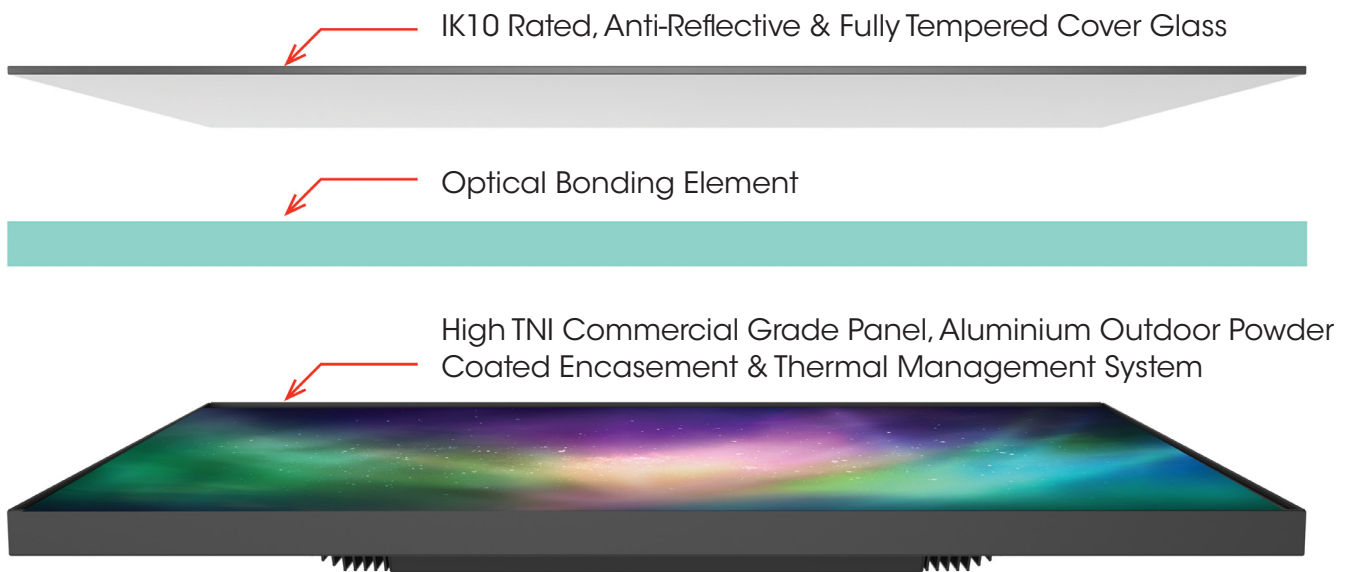

Defining Elements of an Outdoor Commercial Display

High TNI Commercial Display

Prevents Isotropic Blackouts

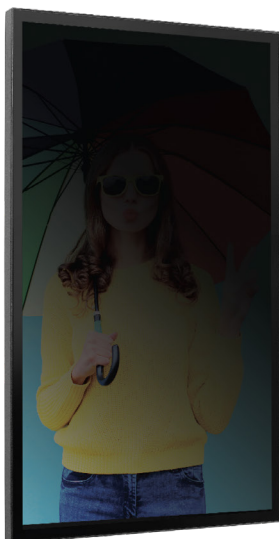

Without High TNI Panel

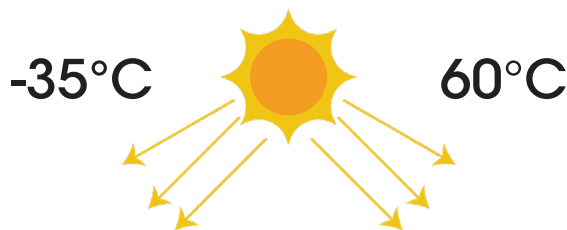

Without an extended heat rating for the LCD panel itself, the probability of having an isotropic blackout is likely. To avoid panel blackouts, a high TNI panel must be used if and when a display is ever to live in direct sunlight.



With High TNI Panel



IK10 Rated Cover Glass

The robustness of the display goes another step further, in that the cover glass is fully tempered, anti-reflective and is IK10 rated*. The IK10 rating states that it will survive 20J of impact energy, making it perfect for public spaces.

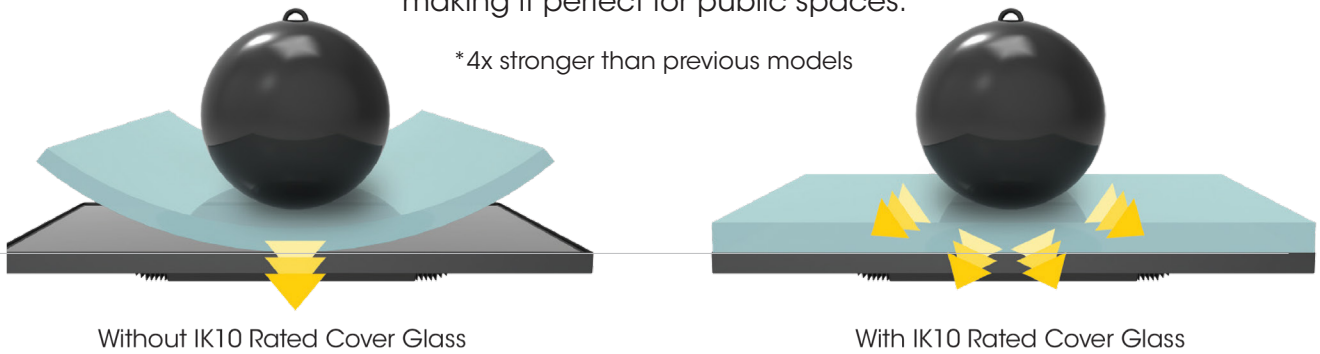

WEATHERPROOF TECHNOLOGY

With an IP66 Rating & a patented thermal exhaust system, the Xtreme™ High Bright Display is fully-sealed, low maintenance & fully protects against water, dust, moisture & insects

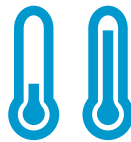

BEST-IN-INDUSTRY TEMPERATURE RANGE

With an operating temperature range of -35°C to 60°C, the Xtreme™ High Bright Display is designed to thrive outside year-round, without worry of extreme hot or cold temperature waves



RESILIENT IK10 RATED SAFETY GLASS

The Xtreme™ High Bright Display's robust IK10 Rated, anti-reflective, impact resistant safety glass fully protects the screen against vandalism & debris



TRULY SUNLIGHT READABLE

The Xtreme™ High Bright Display is optically bonded, which increases the perceived contrast ratio & cuts down on glare, providing amazing picture quality, even in direct sunlight



MANAGED SERVICES COMPATIBLE

Remote & local monitoring is supported via IP Addressable user interface, allowing network operation the ability to view real-time diagnostics & measure proof of performance



HIGH BRIGHT OUTPUT

The Xtreme™ High Bright line of commercial displays offer up to 3000nits of light output to combat high ambient lighting conditions.

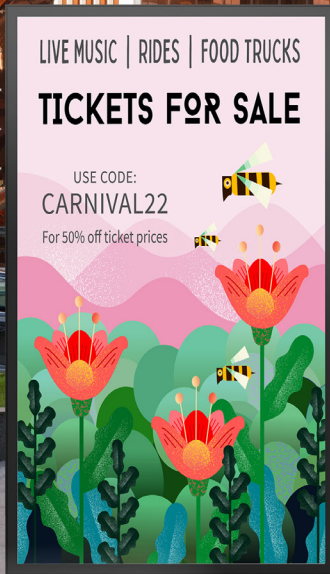

Available Q1 2026

Technical Specifications	
Part No.	Screen
XHB754-EUK	75" Xtreme™ High Bright Outdoor Display

LCD Display

SCREEN SIZE	75" Class (74.5" Diagonal)
ACTIVE SCREEN AREA	64.9" x 36.5" (1650 x 928mm)
PIXEL PITCH	.429mm x .429mm
ASPECT RATIO	16:9
RESOLUTION	3840 x 2160
COLOUR DEPTH	10Bit (1.07 Billion Colors)
BRIGHTNESS	3000cd/m ²
COLOR GAMUT	68% NTSC
BACKLIGHT ADJUSTMENT	Automatic (Ambient Light Sensor)
CONTRAST RATIO	1200:1
VIEWING ANGLE	178° Vertical/Horizontal
DISPLAY ORIENTATION	Portrait/Landscape
BACKLIGHT	Direct LED
RESPONSE TIME	8ms (Gray to Gray)
REFRESH RATE	60Hz
OPERATING TIME	24/7

Environmental

OPERATING TEMPERATURE	-35°C to 60°C (-31°F - 140°F)
IP RATING	IP66
REGULATORY	FCC Class A, cULus, CE

Display Features

Ambient Light Sensor, Auto Source Switching, Brightness Scheduling, Email Alerting, IP Control, Pixel Shift, Power Scheduling

Mechanical

SIZE (W x H x D)	1723.6 x 1002 x 136.1mm (67.86" x 39.45" x 5.36")
COLOUR	Black
GLASS	IK10 Rated Heat Tempered Anti-Reflective Treatment Optically Bonded Quarter Wave Plate Polarizer
VESA® PATTERN	1400 x 300mm 1400 x 600mm
NET WEIGHT	86.0kg (189.6lb)

Power

AC INPUT	100 VAC to 240 VAC, 50 to 60 Hz
POWER CONSUMPTION	600W
STAND BY POWER	Passive Standby = <0.5W Active Standby = <3.0W

Input/Output Connections

HDMI INPUT	HDMI (x2) 480i ~ 2160p CEC: HDMI 1, 2 ARC: HDMI 2
CVBS INPUT	3.5mm (x1) 480i
DISPLAYPORT INPUT	DP (x1) 480i ~ 2160p
YPbPr INPUT	3.5mm (x1) 480i ~ 1080i
ANALOG AUDIO OUTPUT	3.5mm Headphone Jack (x1)
DIGITAL AUDIO OUTPUT	Optical (x1)
USB DATA INPUT	USB 2.0 (x1) Multimedia, Software Upgrade
RS232 INPUT	3.5mm TRS Jack (x1)
12VDC 2.5A OUTPUT	5.5mm (x1)
USB POWER 5VDC 2.4A OUTPUT	USB (x1)
IR EXTENDER INPUT	3.5mm (x1)
IR REPEATER OUTPUT	3.5mm (x1)
AMBIENT LIGHT SENSOR EXTENDER INPUT	3.5mm (x1)
LAN INPUT	RJ-45 (X1)



Technical Specifications	
Part No.	Screen
XHB5541-EUK	55" Xtreme™ High Bright Outdoor Display

LCD Display

SCREEN SIZE	55" Class (54.6" Diagonal)
ACTIVE SCREEN AREA	47.62" x 26.79" (1209.6 x 680.4mm)
PIXEL PITCH	.210 x .630mm
ASPECT RATIO	16:9
RESOLUTION	1920 x 1080
COLOUR DEPTH	8Bit (16.7 Million Colors)
BRIGHTNESS	2,500cd/m ²
COLOUR GAMUT	72% NTSC
BACKLIGHT ADJUSTMENT	Automatic (Ambient Light Sensor)
CONTRAST RATIO	2000:1
VIEWING ANGLE	178° Vertical/Horizontal
DISPLAY ORIENTATION	Portrait/Landscape
BACKLIGHT	Direct LED
RESPONSE TIME	6ms (Gray to Gray)
REFRESH RATE	60Hz
OPERATING TIME	24/7

Environmental

OPERATING TEMPERATURE	-35°C - 60°C (-31°F - 140°F)
IP RATING	IP66
REGULATORY	FCC Class A, cULus, CE

Display Features

Ambient Light Sensor, Auto Source Switching, Brightness Scheduling, Email Alerting, IP Control, Pixel Shift, Power Scheduling

Mechanical

SIZE (W x H x D)	1272 x 742 x 100mm (50.07" x 29.23" x 3.92")
COLOUR	Black
GLASS	IK10 Rated Heat Tempered Anti-Reflective Treatment Optically Bonded Quarter Wave Plate Polarizer
VESA® PATTERN	400 x 200mm 400 x 400mm 600 x 600mm 600 x 850mm
NET WEIGHT	47.4kg (104.5lb)

Power

AC INPUT	100 VAC to 240 VAC, 50 to 60 Hz
POWER CONSUMPTION	ALS Low Mode: 109.9W Typical: 199.3W Maximum: 215W
STANDBY POWER	Passive Standby = <0.5W Active Standby = <2.1W

Input/Output Connections

HDMI INPUT	HDMI (x2) 480i ~ 1080p CEC: HDMI 1, 2 ARC: HDMI 2
CVBS INPUT	3.5mm (x1) 480i
DISPLAYPORT INPUT	DP (x1) 480i ~ 1080p
YPbPr INPUT	3.5mm (x1) 480i ~ 1080i
ANALOG AUDIO OUTPUT	3.5mm Headphone Jack (x1)
DIGITAL AUDIO OUTPUT	Optical (x1)
USB DATA INPUT	USB 2.0 (x1) Multimedia Software Upgrade
RS232 INPUT	3.5mm TRS Jack (x1)
12VDC 2.5A OUTPUT	5.5mm (x1)
USB POWER 5VDC 2.4A OUTPUT	USB (x1)
IR EXTENDER INPUT	3.5mm (x1)
IR REPEATER OUTPUT	3.5mm (x1)
AMBIENT LIGHT SENSOR EXTENDER	3.5mm (x1)
LAN INPUT	RJ-45 (x1)

Outdoor Solutions



If you're looking to install worry-free outdoor digital signage, Peerless-AV is your complete source for kiosks, digital menu boards and mounts that can withstand extreme, all-weather conditions for reliable 24/7 performance in a wide range of unattended applications.

Our Smart City Kiosks and Outdoor Digital Menu Boards provide a rugged solution that helps businesses – whether in the QSR, Local Government, Corporate, Transportation or Attractions space – connect and communicate with their audience in a more effective and efficient way. Trust the experts to ensure a safe, successful installation with minimal maintenance and operating expenditure, since messaging can be changed and updated remotely in just a few clicks. Our mounts are tested to UL2442 safety standards and are e-coated to protect against the elements for a trusted, long term display support solution in any outdoor environment.

Smart City Kiosk Single and Dual Sided Models

- Includes Peerless-AV® 55" (XHB5541-EUK) Xtreme™ High Bright Outdoor Display to offer maximum flexibility
- All stainless steel and aluminium body combined with an outdoor rated paint finish to provide the ultimate in corrosion resistance
- Wind tested up to 135 mph
- Sleek yet rugged design protects the display, while also providing ample space for component storage
- Available in black or silver and with or without speakers to ensure your product needs are met
- KOP55XHB-(S)A-EUK and KOP55XHB2-(S)A-EUK include 4 inch, 100 watt, waterproof speakers to ensure high-quality, undistorted audio output for outdoor usage



All Weather Rated IP66

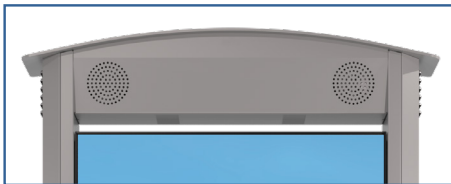

KOP55XHB-(S)A-EUK and KOP55XHB2-(S)A-EUK
Includes Speakers



IP66 Rated display

Fully sealed design prevents the ingress of foreign materials, such as water, dust, moisture and insects, from entering the display

Optional IR Touch Overlay

Create an interactive kiosk by adding the IRT055-XHB4, which can detect up to 10 touch points, whether finger, gloved hand or stylus, all in a convenient plug-and-play design

IP55 Rated Media Cabinet

Provides a dedicated, spacious area for storing AV components, and the integrated fans provide active cooling



Louvered side vents

Allow for display and component ventilation, while keeping cords and other internals hidden from view for a clean install

Extended Base Cover

Allows power and data to be run up through bottom centre, while keeping conduit concealed, for a clean installation

Technical Specifications

Model	Screen	Audio	Ext. size (w x h x d)
KOP55XHB-(S)-EUK	55" XHB5541-EUK	None	899 x 2137 x 252mm
KOP55XHB-(S)A-EUK	55" XHB5541-EUK	2 Speakers	899 x 2137 x 252mm
KOP55XHB2-(S)-EUK	2 x 55" XHB5541-EUK	None	899 x 2137 x 375mm
KOP55XHB2-(S)A-EUK	2 x 55" XHB5541-EUK	4 Speakers	899 x 2137 x 375mm

Smart City Kiosk

- Includes Peerless-AV® 55" (XHB5541-EUK) Xtreme™ High Bright Outdoor Display
- Elegant, minimalistic design covers, protects and ventilates displays and equipment
- No additional layer of glass needed between display and enclosure, eliminating glare
- Wind tested up to 140 mph
- Ambient Light Sensor automatically adjusts brightness to best match the lighting conditions
- Sleek and stylish, yet rugged enough to be installed in any application
- Media storage area. Protects electronic components rated to 10°C above local air temperature with filters and cooling fans (tested to IP54 rating)

Media Storage Area
Protects electronic components rated to 10°C above local air temperature with filters and cooling fans (tested to IP54 rating)



- **Exceptional Readability**
No additional layer of glass needed between the display and kiosk, reducing reflections and glare
- **IP66 Rated Display**
Fully sealed design prevents the ingress of foreign materials, such as water, dust, moisture and insects from entering the display
- **Ultra Slim Design**
Elegant, minimalistic design protects and ventilates display, whilst being rugged enough to be installed in any application
- **Strong & Sturdy**
Bolt down design tested to withstand winds of up to 140mph

SAMSUNG

Solution also available for Samsung 55" OH55F / OH55A-S / OH55DX Displays KOP2555-OHF-EUK

Technical Specifications

Model	Screen	Ext. size (w x h x d)	Display Window	Product Weight
KOP2555(-S)-XHB-EUK	55" XHB5541-EUK	899 x 2091 x 216mm	738 x 1272 mm	160kg (352lb)

Xtreme™ IR Touch Overlay for stand alone install & use with KOP55XHB(2)-EUK Kiosks

Effortlessly upgrade your Smart City Kiosk into an interactive user experience with the IR Touch Overlay accessory. This IR Touch Overlay is designed specifically for the Smart City Kiosk's integrated 55" Xtreme™ High Bright Outdoor Display. It is manufactured with a stainless steel chassis, ensuring durable, lasting performance. With the incorporated infrared technology, the overlay is capable of responding to ten simultaneous points of touch and can detect any input including a bare finger, gloved finger, or stylus.

- 10 points simultaneous touch allows for flexibility in content selection
- All Weather Rated IP65
- Made from powder coated stainless steel
- Operating Temperature Range: -10°C to 40°C
- Easy setup
- HID-compliant
- Exceptional response time ≤15ms
- Can be installed in either Landscape or Portrait orientation



Technical Specifications

Model	Compatible With	Compatible Operating Systems	Touch Response
IRTO55-XHB4	Stand alone install or for use with KOP55XHB-EUK & KOP55XHB2-EUK	Microsoft®, Windows®, Google®, Chrome®, Android®, MacOS® and many popular Linux® Distributions - HID Compliant	≤15ms



Outdoor Digital Signage Boards

peerless-AV®

LG

SAMSUNG

- Elegant, minimalistic design protects displays and internal equipment, while enhancing the drive-thru aesthetics
- Designed for common 8" baseplate mounting pattern, with 30° of rotational positioning to select the best viewing angle for your customers
- Pedestal enclosure designed and tested to IP54
- Create a fully integrated drive-thru solution with a variety of options:
 - Speaker/Microphone Kit (KOF-OPT-SPK)
Contact sales for further info
 - Media Storage Fan (KOF-OPT-FAN-EUK)
 - Internal Media Player Shelf (KOF-OPT-SHELF)



■ **Site Security**
Captive security fasteners prevent unauthorised access and vandalism

■ **Ultra Slim Design**
Sleek and stylish, yet rugged enough to be installed in any outdoor application for 24/7 use

■ **Modular Design**
Displays can be installed from the front, without disturbing the adjacent units



■ **Pedestal base**
Allows for mounting to existing footing, thus eliminating the need for pouring new concrete*
*As long as it meets the requirements for various wind load specifications

Technical Specifications

Model	Supports	Number of displays	Ext. size (w x h x d)	Product Weight
KOF555-1-EUK	55" XHB5541-EUK	Single	721 x 1922 x 321mm	60kg
KOF555-2-EUK	55" XHB5541-EUK	Double	1452 x 1922 x 321mm	74kg
KOF555-3-EUK	55" XHB5541-EUK	Triple	2184 x 1922 x 321mm	88kg
KOF555-1-LGE-EUK	55" 55XE4F-M / 55XE3P-B	Single	721 x 1922 x 321mm	60kg
KOF555-2-LGE-EUK	55" 55XE4F-M / 55XE3P-B	Double	1452 x 1922 x 321mm	74kg
KOF555-3-LGE-EUK	55" 55XE4F-M / 55XE3P-B	Triple	2184 x 1922 x 321mm	88kg
KOF555-1-SAM-EUK	55" OH55F / OH55A-S / OH55DX	Single	721 x 1922 x 321mm	60kg
KOF555-2-SAM-EUK	55" OH55F / OH55A-S / OH55DX	Double	1452 x 1922 x 321mm	74kg
KOF555-3-SAM-EUK	55" OH55F / OH55A-S / OH55DX	Triple	2184 x 1922 x 321mm	88kg



Outdoor flat wall mount

- Designed specifically for outdoor use and constructed from weatherproof materials
- Up to 7.4" (189mm) of horizontal positioning
- Hinged adaptors ease installation of hardware to the rear of the display
- Hook-and-Hang™ Installation means display is easily installed by a single person
- Security latch locks the pull cords to prevent unauthorized access (security allen wrench required)

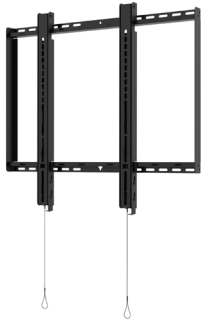

Technical Specifications			
Part No.	Screen Size	Weight	Mounting Pattern
ESF686	65-86"	91kg	VESA® up to 700 x 600mm

Corrosion resistant flat & tilt portrait mount

- Designed specifically for outdoor use and constructed from weatherproof materials
- Universal display adapters easily hook onto the wall plate for fast installation
- Safety latch ensures display is securely attached to wall plate
- Low-profile design holds display only 1.77" (45mm) from the wall for a clean application



Technical Specifications			
Part No.	Screen Size	Weight	Mounting Pattern
ESF655P (Flat)	42-80"	68kg	Up to 400 x 600mm
EST655P (Tilt)	42-80"	68kg	Up to 400 x 600mm

Corrosion resistant tilt wall mount

- Made of corrosion resistant materials for weather resistance
- One-Touch™ tilt allows adjustment of +15/-5° with optional tilt lock in 5° increments
- Horizontal display adjustment up to 8" (203mm) for better display placement
- 2.64" (67mm) from the wall
- Double stud mounting with 16", 20" & 24" stud placements
- Tamper-resistant hardware is standard and also has accommodations for optional padlocks
- Wood, concrete or cinder block mounting hardware included

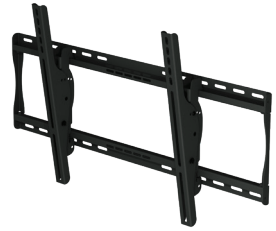

Technical Specifications			
Part No.	Screen Size	Weight	Mounting Pattern
EPT650	32-75"	79kg	Up to 600 x 400mm

Corrosion resistant tilt wall mount

- For Indoor/Outdoor use where corrosion protection and weather resistance is needed
- Adjustable +15° forward and -5° backward tilt for optimal viewing angle
- Low profile design holds display 53mm from the wall for a discreet installation
- Mounts to wood stud, concrete, cinder or breeze block
- Includes all necessary wall and display attachment hardware



Technical Specifications			
Part No.	Screen Size	Weight	Mounting Pattern
EPT630	22-40"	36kg	VESA® 100mm

Outdoor articulating wall mount

- Universal model extends from 4.50" (114mm) to 22.72" (577mm) from the wall
- Open wall plate design for increased wall access and improved aesthetic
- Universal mounting pattern accommodates a variety of display mounting patterns
- IncreLok™ tilt allows adjustment of +15°/-5°
- Includes all necessary wall and display attachment hardware

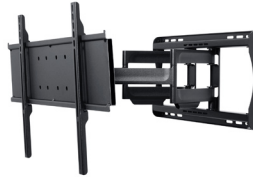

Technical Specifications			
Part No.	Screen Size	Weight	Mounting Pattern
EPA762PU	42-75"	68kg	Up to 600 x 400mm

Corrosion resistant articulating mount

- Dual arm construction for added strength and smooth motion on larger displays
- Universal model extends from 4.44" (113mm) to 27.94" (710mm) from the wall
- Minimalistic wall plate footprint for increased wall access and improved aesthetic
- Integrated cable management provides ample area to run cables to complete a professional and discrete installation
- IncreLok™ tilt allows adjustment of +15°/-5°

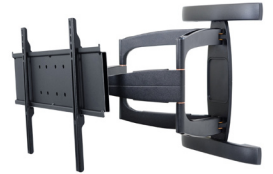

Technical Specifications			
Part No.	Screen Size	Weight	Mounting Pattern
ESA763PU	32-86"	91kg	Up to 600 x 400mm



LG Outdoor Tilt Wall Mounts

- Adaptors hook onto the wall plate, simplifying the install
- IncreLok™ tilt locks the display at 0°, 2° or 4°
- Clean profile design hides cables and hardware within enclosed wall plate for a clutter-free installation
- Security hardware deters tampering and theft
- Air baffles help separate exhaust from intake air



Technical Specifications		
Model	Compatible LG Screen	Orientation
EWL-49XE4F	49XE4F (49")	Landscape
EWP-49XE4F	49XE4F (49")	Portrait
EWL-55XE4F	55XE4F (55")	Landscape
EWP-55XE4F	55XE4F (55")	Portrait

Indoor Information & Wayfinding Kiosks



Customise any kiosk with bespoke colouring to perfectly match brand guidelines or create an appearance that works with the aesthetics of the location.

With new interactive technologies such as touch, gesture, dynamic media and mobile devices replacing traditional static information points in so many different vertical markets, it's no wonder that relevant mounting solutions have been required to expand to cater for this opportunity. Introducing Peerless-AV's sleek digital signage kiosk range, designed to best support the latest ultra-thin LCD displays and touchscreen panels from 40" to 65".

Choose from a versatile array of sleek, slim and attractive kiosk enclosures that are sure to make an impact with your audience. Whether it's advertising, a digital directory or wayfinding, these solutions are an ideal fit for corporate, public transport, hospitality, education, hospital, retail store, shopping centre and many more applications.

This complete range includes solutions for single and back-to-back displays in portrait or landscape orientation.

Products are supplied in silver finish as standard. However, custom paint colours and vinyl wraps can be an option to complement existing aesthetics or to satisfy client branding requirements.

Contact us on +44 (0) 1923 200 100 or sales@peerless-av.co.uk for more information or to discuss custom quotations

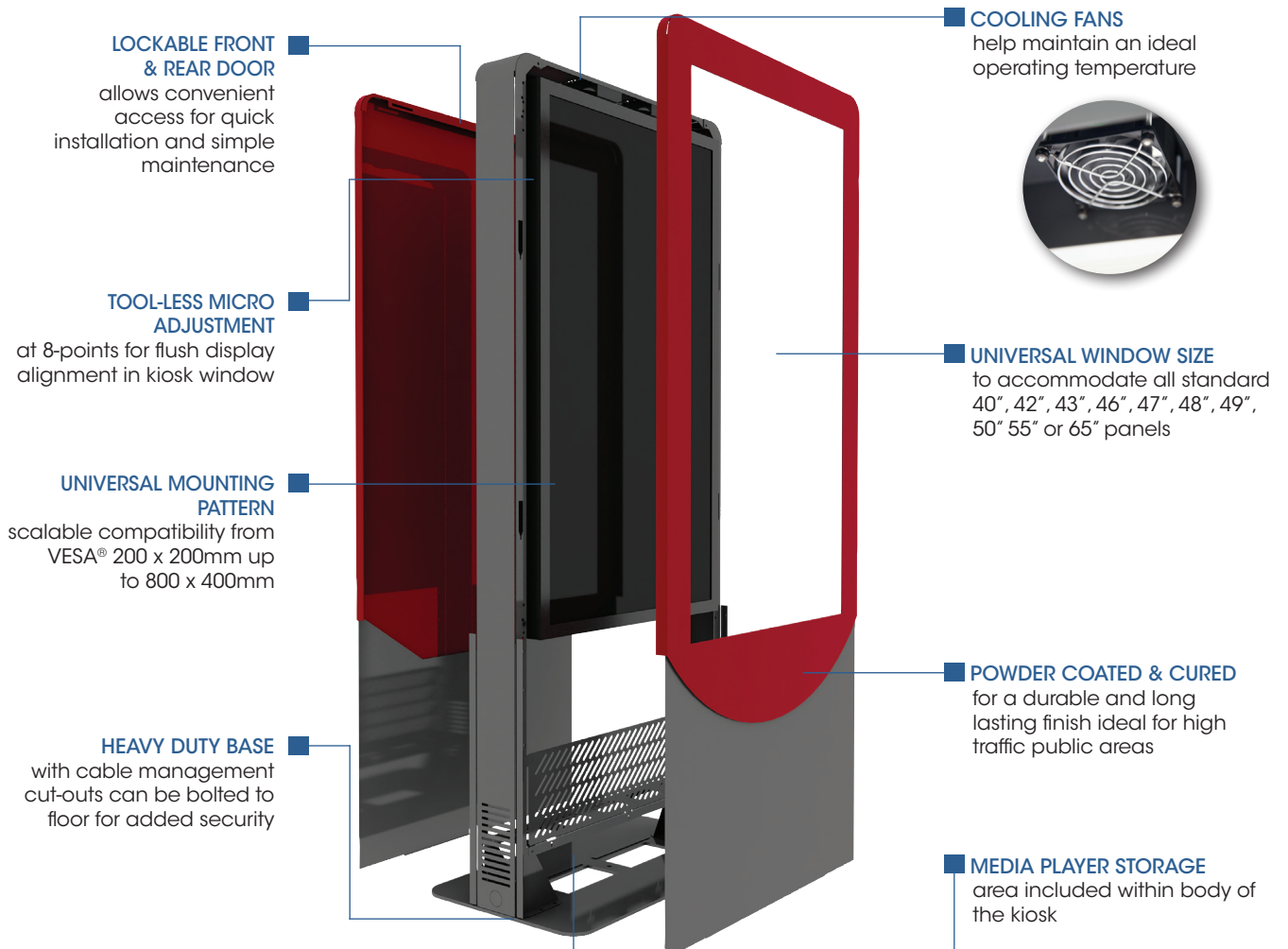

Universal Indoor Floorstanding Portrait Kiosk



- Designed to accommodate displays up to 101mm deep (4")
- Lift off bi-level doors allowing access to parts requiring maintenance
- Internal micro-adjustments allow for quick positioning of display within the kiosk window for flush alignment
- Two whisper quiet thermostatically controlled cooling fans to exhaust heat generated from the display and components
- Keyed locks prevent theft and tampering with display and components
- Internal component tray to store media player and keep cables hidden for a professional looking finish
- Flat base can be free standing or bolted to the ground and allows for electrical and data cable access
- Supports a wide range of aesthetic options, including multiple colours and vinyl wraps, to match any branding strategy

Technical Specifications				
Model	Screen Size	Kiosk Dimensions	Height to Screen centre	Display Window
KIPC2540-EUK	40"	711 x 1835 x 457mm	1278mm	500 x 888mm
KIPC2542-EUK	42"	711 x 1835 x 457mm	1267mm	525 x 933mm
KIPC2543-EUK	43"	711 x 1835 x 457mm	1262mm	537 x 955mm
KIPC2546-EUK	46"	787 x 1835 x 457mm	1212mm	574 x 1021mm
KIPC2547-EUK	47"	787 x 1835 x 457mm	1207mm	587 x 1043mm
KIPC2548-EUK	48"	787 x 1835 x 457mm	1201mm	599 x 1065mm
KIPC2549-EUK	49"	864 x 1987 x 483mm	1311mm	613 x 1087mm
KIPC2550-EUK	50"	864 x 1987 x 483mm	1306mm	626 x 1109mm
KIPC2555-EUK	55"	864 x 1987 x 483mm	1275mm	686 x 1220mm
KIPC2565-EUK	65"	1016 x 2194 x 533mm	1654mm	813 x 1441mm

Universal Indoor Floorstanding Portrait Back-To-Back Kiosk



- Accommodates ultra-thin or deeper commercial displays up to 46mm* thick, while accentuating the slim, curvature kiosk design
- Designed with architectural steel and a 3/8" steel base plate that provides stability, strength and corrosion resistance
- Two whisper quiet thermostatically controlled cooling fans to exhaust heat generated from the display and components
- Internal micro-adjustments allow for quick positioning of display within the kiosk window for flush alignment
- Secured doors allow convenient access to the display, media player and other internal components for easy installation and maintenance
- Supports a wide range of aesthetic options, including multiple colours and vinyl wraps, to match any branding strategy

*Deeper models also available (KIPC25%B-3-EUK) to accommodate displays up to 76mm thick

Technical Specifications				
Model	Screen Size	Kiosk Dimensions	Display Window	Colour
KIPC2540B-EUK	40"	711 x 1835 x 457mm	500 x 888mm	Silver, Black or Custom
KIPC2542B-EUK	42"	711 x 1835 x 457mm	525 x 933mm	Silver, Black or Custom
KIPC2543B-EUK	43"	711 x 1835 x 457mm	537 x 955mm	Silver, Black or Custom
KIPC2546B-EUK	46"	787 x 1835 x 457mm	574 x 1021mm	Silver, Black or Custom
KIPC2547B-EUK	47"	787 x 1835 x 457mm	587 x 1043mm	Silver, Black or Custom
KIPC2548B-EUK	48"	787 x 1835 x 457mm	599 x 1066mm	Silver, Black or Custom
KIPC2549B-EUK	49"	864 x 1987 x 483mm	613 x 1087mm	Silver, Black or Custom
KIPC2550B-EUK	50"	864 x 1987 x 483mm	626 x 1109mm	Silver, Black or Custom
KIPC2555B-EUK	55"	864 x 1987 x 483mm	686 x 1220mm	Silver, Black or Custom
KIPC2565B-EUK	65"	1016 x 2194 x 533mm	813 x 1441mm	Silver, Black or Custom

Landscape/Portrait Kiosk Fits most 15", 22", or 32" Displays



- A wide range of custom aesthetic options also available; options include custom color finishes, vinyl logos, wraps, etc
- Mount the display in landscape or portrait orientation to fit your digital signage needs
- Stylish kiosk body. Allows for the ultimate placement flexibility
- High-performance, premium powder coat finish. Protects the unit and extends the product lifespan for years
- Tested to UL safety standards
- Internal storage. Safely store media players, routers and other components
- Internal cable management. Creates an aesthetically pleasing appearance
- Secured rear doors. Deters theft and allows convenient access to the display and other internal components for easy maintenance
- Flat rectangular base. Unobtrusive, stylish design can be free-standing or bolted to the floor for increased safety and security
- Stand-alone or fully integrated with display, audio components, media player and input components

Technical Specifications			
Model	Screen Size	Max Weight	Ext. size (w x h x d)
KIP522-EUK	15" 22" or 32"	22.6kg (50lb)	333 x 1357 x 406mm

Hourglass Landscape Kiosk

Fits most 40", 42", 43", 46", 47", 48", 49", 50" and 55" displays less than 89mm deep



- Designed to accommodate latest touch screen and digital signage displays (up to 89mm depth) in a stylish floor standing kiosk
- Modern hourglass body design with a curved, corner pull-out display cover
- Display lies flush with the kiosk window for a clean integrated appearance
- Unobtrusive, stylish flat base panel can be free standing or bolted to floor for increased safety and security
- Internal component tray to store media player and cables neatly for a professional finish (*internal size 215 x 317 x 101mm*)
- High-performance, premium powder coat finish protects the unit and extends the product lifespan for years
- Available in black or silver finish as standard this unit can support a wide range of aesthetic options including multiple colours, vinyl wraps, etc. to best match the environment or promote brand strategy
- For theft protection, the kiosk features hex pin screw locks

Technical Specifications			
Model	Screen Size	Max Weight	Ext. size (w x h x d)
KILH540-EUK	40"	34kg (75lb)	1063 x 1362 x 470mm
KILH542-EUK	42"	34kg (75lb)	1063 x 1362 x 470mm
KILH543-EUK	43"	34kg (75lb)	1063 x 1362 x 470mm
KILH546-EUK	46"	34kg (75lb)	1174 x 1389 x 470mm
KILH547-EUK	47"	34kg (75lb)	1174 x 1389 x 470mm
KILH548-EUK	48"	34kg (75lb)	1174 x 1389 x 470mm
KILH549-EUK	49"	34kg (75lb)	1221 x 1398 x 470mm
KILH550-EUK	50"	34kg (75lb)	1221 x 1398 x 470mm
KILH555-EUK	55"	34kg (75lb)	1332 x 1426 x 470mm





Customise Your Kiosk

With many public and private spaces becoming ever more congested with digital signage content, it is important to clients that their message stands out in the crowd. Whether a kiosk branded with the client logo or in their corporate colours, or a solution where the kiosk graphics carry through the marketing theme. To support this requirement, Peerless-AV offers the ability to personalise any of the kiosk range with a choice of three different client branding options.

Custom Colour Finish



This delivers a kiosk that is finished in a bespoke colour to perfectly match client brand guidelines or to create an appearance that works with the aesthetics and decor of the location. Components are powder coated in the same way as a standard Peerless-AV kiosk and are delivered fully assembled.

Vinyl Logo / Graphic

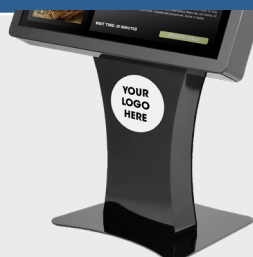

Kiosk models are available in either a Black or Silver (-S) powder coated finish as standard, to which it is possible to add a vinyl graphic. This could be anything from a company logo, marketing message or a product image for a semi-permanent static brand statement.

Full Vinyl Wrap

To create a branding statement without compromise, a complete vinyl wrap is the ultimate canvas on which to deliver your message. Creating a stunning, seamless appearance in full colour. The only limit to the designs that can be achieved is your imagination.

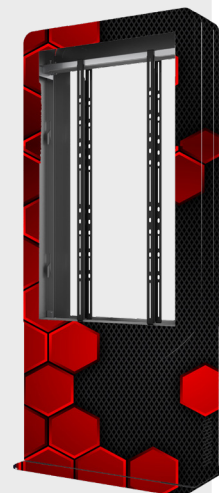

Peerless-AV also offer add-on additional technology components for boosted functionality

Speakers

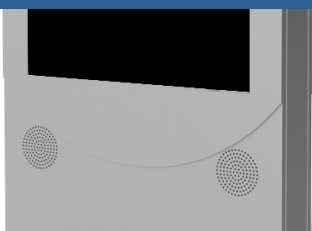

Add speakers to boost end user communication.

Camera



Add a camera to capture real-time video and enhance interactivity.

Wheel Base



Add a wheeled base for ease of movement.

Modular Series Projector Mount Kit



Peerless-AV constantly strives to improve the versatility and ease of use of our products. Having listened to the feedback from installers and integrators, it was apparent that the market required a product range that could fulfil multiple requirements from a limited number of SKUs. The Modular Series was created as a universal ceiling mount solution with component options making up the full projector mount range.

With the ability to select the required ceiling plate and column length, along with a choice of projector mounts and adaptor plates this is an incredibly versatile system. If that wasn't simple enough Peerless-AV has created one-box kit that will be perfect for many professional installations. Manufactured from the highest quality materials and tested in excess of industry standards the Modular Series provides the assurance of durability and safety.

MOD-PJF2KIT100-B MOD-PJF2KIT150-B Modular Series PJF2 Projector Mount Ceiling Kit

1 x MOD-CPC:	Cathedral ceiling plate
1 x MOD-Pxxx:*	Black extension pole (1m) or 59" (1.5m)
1 x MOD-ATA:	Projector Mount Adaptor
1 x PJF2:	PJF2 Projector Mount

* Pole part number depends on drop length required

- Cathedral Ceiling Plate can be angled $\pm 60^\circ$ for use with vaulted or sloping ceilings
- Configurable projector installation with drops of 39" (1m) or 59" (1.5m) in height
- Universal Spider® Adaptor designed to work with nearly all projectors weighing up to 22kg (50lb)
- Ball and socket design provide simple tilt, roll and swivel adjustments
- Specifications:
Tilt: $\pm 15^\circ$
Roll: $\pm 15^\circ$
Swivel: 360°
All with positive lock at any degree



Heavy Duty ceiling plate option - CPF

MOD-PJF2KIT100-CPF-B MOD-PJF2KIT150-CPF-B Modular Series PJF2 Projector Mount Ceiling Kit

1 x MOD-CPF:	Ceiling Plate
1 x MOD-Pxxx:*	Black extension pole 39" (1m) or 59" (1.5m)
1 x MOD-ATA:	Projector Mount Adaptor
1 x PJF2:	PJF2 Projector Mount

* Pole part number depends on drop length required

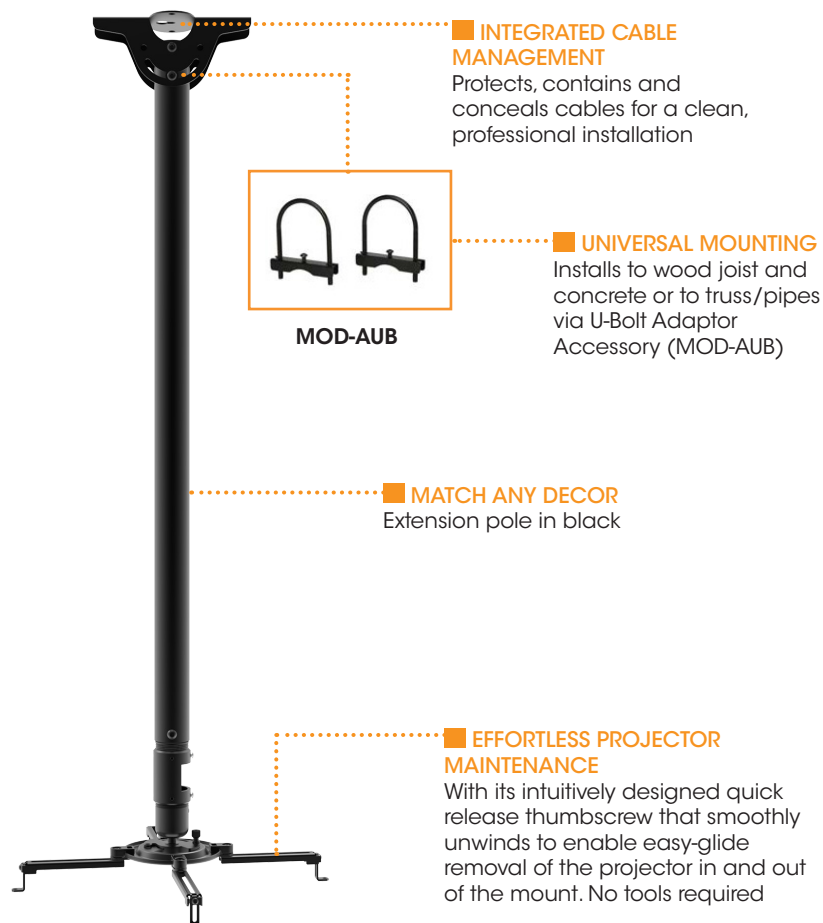





Configure Your Bespoke Solution in 4 Simple Stages

1 Choose the ceiling plate

	<p>Heavy Duty Ceiling/Floor Plate MOD-CPF (Black) MOD-CPF-W (White) Mounts to concrete & wood joist ceilings Max Weight: 170kg (374lbs)</p>
	<p>Ceiling Plate Cover MOD-ACF (black) MOD-ACF-W (white) Cover for MOD-CPF ceiling/floor plate</p>
	<p>Cathedral Ceiling Plate MOD-CPC (Black) MOD-CPC-W (White) Mounts to concrete & wood joist ceilings Tilt: +/- 60° Max Weight: 120kg (264lbs)</p>
	<p>I-Beam Ceiling Plate MOD-CPI (Black) Fully adjustable for I-beams 85mm to 250mm wide Tilt: +/- 60° Max Weight: 120kg (264lbs)</p>
	<p>U-Bolt Accessory Kit MOD-AUB (Black) Clamps around 40mm to 85mm (1.5-3.3") diameter pipes, trusses etc. Adapts to MOD-CPC & MOD-CPF Max Weight: 120kg (264lbs)</p>

2 Select the pole length & accessories

	<p>Extension Poles MOD-P100 1.0m (39") MOD-P150 1.5m (59") MOD-P200 2.0m (78") MOD-P300 3.0m (118") Also available in White (add '-W' to Part No.) and Black (add '-B' to Part No.)</p>
	<p>Trim Disc MOD-ATD-W (White) Fits around 50mm pole to clean up rough cut through false ceiling tile</p>
	<p>Pole Coupler MOD-APC Connects 2 x 50mm poles</p>
	<p>Pole Drill Fixture MOD-ADF (Black) Allows marking and positioning of new installation holes to be drilled into newly cut 50mm poles</p>

3 Projector adaptor plate

	<p>Projector Mount Adaptor MOD-ATA Adaptor for using PRG-UNV, PRGS-UNV with modular extension poles</p>
---	--

Kits - Part No.	Convenient Single Box Solutions
MOD-PJF2KIT100-B	Kit includes: 1 x MOD-CPC Cathedral Ceiling Plate 1 x MOD-P100-B 1.0m Extension Pole 1 x MOD-ATA Projector Mount Adaptor 1 x PJF2 Projector Mount 1 x ACC850 Column Connector with Cord Management
MOD-PJF2KIT150-B	Kit includes: 1 x MOD-CPC Cathedral Ceiling Plate 1 x MOD-P150-B 1.5m Extension Pole 1 x MOD-ATA Projector Mount Adaptor 1 x PJF2 Projector Mount 1 x ACC850 Column Connector with Cord Management
MOD-PJF2KIT100-CPF-B	Kit includes: 1 x MOD-CPF Ceiling Plate 1 x MOD-P100-B 1m Extension Pole 1 x MOD-ATA Projector Mount Adaptor 1 x PJF2 Projector Mount 1 x ACC850 Column Connector with Cord Management
MOD-PJF2KIT150-CPF-B	Kit includes: 1 x MOD-CPF Ceiling Plate 1 x MOD-P150-B 1.5m Extension Pole 1 x MOD-ATA Projector Mount Adaptor 1 x PJF2 Projector Mount 1 x ACC850 Column Connector with Cord Management

4 Required projector mount

	<p>PRG Projector Mount PRG-UNV (Black) Also available in White (-W) Pitch: ±20° Swivel: 360° Roll: ±10° Max Weight: 22kg (50lbs) Mounting Pattern: Universal up to 448mm</p>
	<p>PRGS Projector Mount PRGS-UNV(Black) Also available in White(-W) Pitch: +15°/-20° Swivel: 360° Roll: ±5° Max Weight: 22kg (50lbs) Mounting Pattern: Universal up to 448mm</p>
	<p>PJF2 Projector Mount PJF2-UNV(Black) Pitch: ±15° Swivel: 360° Roll: ±15° Max Weight: 22kg (50lbs) Mounting Pattern: Universal up to 448mm</p>
	<p>Heavy Duty Projector Mount PJR125-EUK (Black) also available as a portrait model (PJR125-POR-EUK) Pitch: +15°/-5° Swivel: 360° Roll: +/-5° Max Weight: 57kg (125lbs)</p>
	<p>Projector Enclosure* PE1120 (Black) Also available in White (-W) as shown * does not include projector mount Secures and protects virtually any projector and mount up to 508 x 508 x 280mm (20 x 20 x 11") (WxDxH)</p>

PJR250 Heavy Duty Projector Mount



*Shown with PAP250-NEC1 Dedicated Adaptor Plate

- Pre-assembled design reduces installation time
- Slide the projector side-to-side up to 3" for perfect image alignment
- Dedicated adaptor plates reduce sag and simplify adjustments
- Cable management allows cables to be routed through projector mount and out of sight
- A safety cable is included to provide assurance
- Multiple locations are built-in to secure cabling from the column to the projector
- Simple Hook-and-Hang™ design eases the installation of heavy projectors
- ±1.5" (38mm) of lateral shift built into the mount
- Lock the projector at any angle with the adjustment screws
- Works with Peerless-AV® ADD%, AEC%, EXT%, MOD% extension columns

Technical Specifications			
Part No.	Pitch, Roll, Swivel	Colour	Max. weight
PJR250	+15°/-5°, ±5°, 360°	Black	113kg (250lb)

Dedicated Adaptor Plates

Part Number	Compatible With:
PAP250-CHRISTIE1	Dedicated Adaptor Plate for Roadster HD6K-M, HD10K-M, HD-14KM, WU7K-M, WU12K-M, WU14K-M and HS D13WU-HS, D13HD-HS projector models
PAP250-CHRISTIE2	Dedicated Adaptor Plate for Crimson HD25, Crimson WU25 projector models
PAP250-CHRISTIE3	Dedicated Adaptor Plate for Boxer2K20, 2K25, 2K30, 30, 4K20, 4K30 projector models
PAP250-BARCO1	Dedicated Adaptor Plate for UDX Series projector models
PAP250-EPSON1	Dedicated Adaptor Plate for EPSON Pro L25000U projector model
PAP250-NEC1	Dedicated Adaptor Plate for NP-PX1004UL-B, NP-PX1004UL-BK, NP-PX1004UL-W, NP-PX1004UL-WH, NP-PX803UL-B-18, NP-PX803UL-BK, NP-PX803UL-W, NP-PX803UL-WH, PX750CM, NC1000C, NC1000C-IMS, NC1100L-A, NC1201L-A, NC1201L-IMS, NC1700L-IMS, NP-PH1201QL, NP-PH1202HL, NP-PH1202HL1 and PH1000U projector models
PAP250-PANA1	Dedicated Adaptor Plate for Panasonic projectors PT-EX16K, PT-RQ32K, PT-RZ31K & RS30K
PAP250-PANA2	Dedicated Adaptor Plate for Panasonic projectors PT-DZ21K2, PT-DS20K2, PT-DW17K2, PT-DZ16K2, PT-EX12K, PT-RQ13K, PT-RQ22K, PT-RZ12K, PT-RZ21K & PT-RS11K
PAP250-PANA3	Dedicated Adaptor Plate for Panasonic projectors PT-DZ13K, DS12K, DW11K & DZ10K

PJR125-EUK / PJR125-POR-EUK Heavy Duty Projector Mount

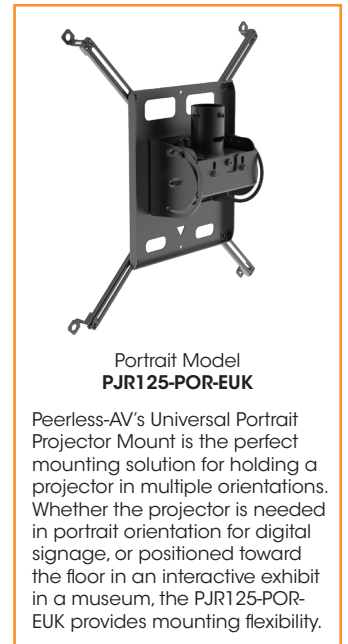

- Pre-assembled design reduces installation time
- Includes six universal mounting legs (four pre installed)
- Universal adaptor plate extends up to a 25.5" (648mm) mounting pattern to accommodate most projector models
- Cable management allows cables to be routed through the mount and out of sight
- Low profile design, creates an aesthetically appealing look
- Simple Hook-and-Hang™ design eases the installation of heavy projectors
- Works with Peerless-AV® ADD%, AEC%, EXT%, MOD% extension columns

Technical Specifications				
Part No.	Pitch, Roll, Swivel	Colour	Orientation	Max. weight
PJR125-EUK	+15°/-5°, +/-5°, 360°	Black	Landscape	57kg (125lb)
PJR125-POR-EUK	Landscape: +/-100°, +/-6°, 360° Portrait: +/-20°, +/-100°, 360° Floor: +10°/-190°, +/-20°, 360°	Black	Landscape, Portrait, Floor	57kg (125lb)



PRG Projector Mount

- Patent pending precision gear provides ImageLock™ alignment to accurately hold image position, without any sag or drift
- Two adjustment controls for tilt and roll image alignment – engage using a Phillips screwdriver or adjust by hand
- Spider® universal adaptor plate extends up to 448mm to fit most projector models
- Can be flush mounted or used with extension poles and plates
- Quick release mechanism to easily service projector
- Pre-installed security screws prevent tampering with adjustment controls
- Cable management allows cables to be routed through projector mount and out of sight
- Available in black and white (-W) finishes



Compatible with both Peerless-AV Modular ceiling kits and Peerless-AV Pro ceiling kits

Technical Specifications

Part No.	Pitch/Swivel/Roll	Colour	Max. weight	Mounting pattern
PRG-UNV	±20°, 360°, ±10°	Black	22kg (50lbs)	Universal (up to 448mm)

PRGS Projector Mount

- Two adjustment knobs to control tilt and roll image alignment and accurately hold image position, virtually eliminating any sag or drift
- Pre-installed security screws provide optional tilt and roll lock to prevent tampering and adjustments
- Low profile design allows projector to be flush with the ceiling
- Achieve pin-point image alignment by simply turning the adjustment knobs by hand or with a Phillips screwdriver
- Quick-release thumbscrew enables easy-glide removal of the projector in and out of the mount
- "U" pitch bracket for easy cable routing
- Includes the Spider® Universal Adapter Plate which extends up to 17.63" (448mm) to fit most projector models



Technical Specifications

Part No.	Pitch/Swivel/Roll	Colour	Max. weight	Mounting pattern
PRGS-UNV	+15°/-20°, 360°, ±5°	Black or White	22kg (50lbs)	Universal (up to 448mm)

PJF2 Projector Mount

- Single point of adjustment for quick image alignment
- Specifications: Tilt: ±15°, Roll: ±15° Swivel: 360° - all with positive lock at any degree
- Effortless maintenance with quick-release thumbscrew to enable easy-glide removal of the projector in and out of the mount. No tools required.
- Structural ceiling plate included for flush mounting applications
- Features a 38 mm cable access hole allowing cables to be routed through projector mount out of sight
- Pre-installed security screws at all connection points
- Includes the Spider® Universal Adapter Plate which extends up to 448 mm to fit most projector models



Technical Specifications

Part No.	Pitch/Swivel/Roll	Colour	Max. weight	Mounting pattern
PJF2-UNV	±15°, 360°, ±15°	Black	22kg (50lbs)	Universal (up to 448mm)

PE1120 Projector Enclosure

- Secures and protects virtually any projector and mount up to 508 x 508 x 280mm (WxDxH)
- Retro-fit capable without altering existing installation
- Adjustment bars accommodate projector lens placement
- For use with Peerless projector mounts, ceiling plates and extension poles
- 'Hook-n-Hang' feature allows hands-free operation during projector installation or maintenance
- Projector mount purchased separately
- Available in black or white (-W) finish



Technical Specifications

Part No.	Pitch/Swivel/Roll	Colour	Max. weight	Mounting pattern
PE1120	N/A	Black or White	N/A	508x508x280mm (WxDxH)

Desktop & Wall Monitor Mounts



Peerless-AV's Desktop Mounts provide flexible single and double monitor positioning with limitless mounting options on any desk or counter top surface.

The range offers a replacement to the stands provided 'in-the-box' provided by monitor manufacturers. Key features include an attractive finish, derived from the polished aluminium articulating arms with chrome and gloss black accents.

All have integrated cable management to protect and conceal cables for a clean and professional installation.

1x2 Freestanding Desktop Stand for 24" to 49" Ultra-Wide Curved Monitors

Peerless-AV's 1x2 Freestanding Desktop Stand offers a secure, functional and convenient mounting solution for 24" to 49" ultra-wide curved monitors, ideal for gaming and streaming, security, control rooms, and trade market applications. The unique design allows (2) monitors to be stacked in a 1x2 layout to maximize the ability to simultaneously view multiple sources. A built-in adjustment knob allows the user to precisely position the monitors to eliminate any gap between the bezels. The slim base provides a sturdy support for the mounted monitors and a clean look ideal for any work space.

- Universal design works with 24" to 49" ultra-wide curved or flat monitors with 75 x 75 or 100 x 100mm VESA® patterns
- Internal cable management conceals all cabling for a clean and clutter free installation
- Low profile base is freestanding for convenient set up
- Hook-and-Hang™ adaptors help reduce installation and maintenance time, and allow monitors to be swapped out quickly

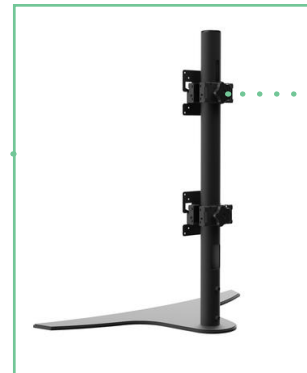
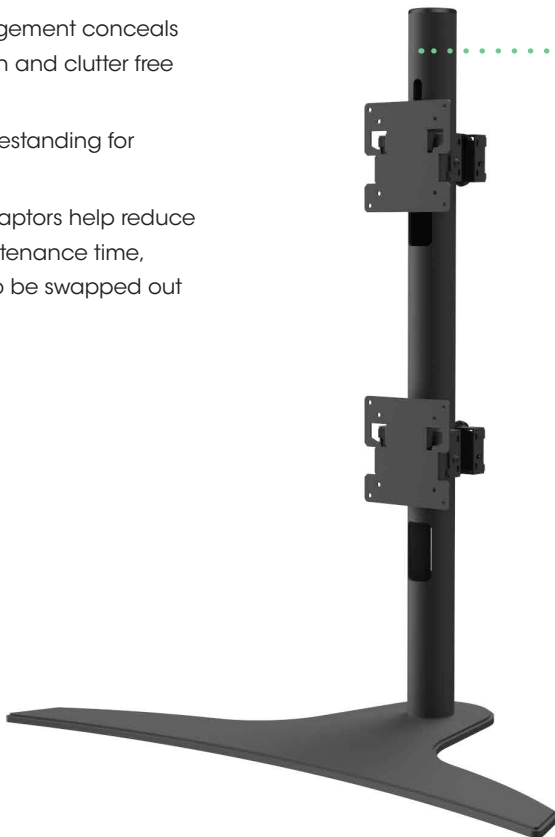
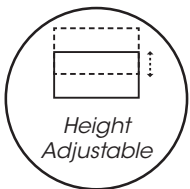

HEIGHT ADJUSTABLE DESIGN
The top monitor can be adjusted vertically along the column to provide the proper spacing for stacking two monitors



Technical Specifications

Part No.	Dimensions	Max. Weight	Finish	Colour
LCT650SD	704 x 757 x 365mm	27.2kg (60lb)	Scratch Resistant Fused Epoxy	Matte Black

Desktop Monitor Arm Mount

- Accommodates different monitor weights ranging from 8.4lb to 17.8lb (3.8kg to 8.1kg)
- Compatible with VESA® 75 x 75mm and 100 x 100mm mounting patterns
- Display can be rotated from landscape to portrait
- Cable management clips keep cables organized and out of the way
- 12.6" of height adjustment, 22" of extension adjustment, +45°/-90° of tilt, 180° of swivel and 360° of rotation
- Accommodate a desktop or counter thickness of 5 to 55mm thick



Technical Specifications

Part No.	Screen Size	Fixing Type
LCT620A	Up to 38"	Clamp base
LCT620A-G	Up to 38"	Grommet base

Articulating Wall Mount

- Accommodates different monitor weights ranging from 8.4lb to 17.8lb (3.8kg to 8.1kg)
- Compatible with VESA® 75 x 75 and 100 x 100mm mounting patterns
- Display can be rotated from landscape to portrait
- Cable management clips keep cables organized and out of the way
- 12.6" of height adjustment, 22" of extension adjustment, +45°/-90° of tilt, 180° of swivel and 360° of rotation
- Wall mounted. Place monitors where needed even without a desk



Technical Specifications

Part No.	Screen Size	Fixing Type
LCW620A	Up to 38"	Wall mount

Dual Monitor Desktop Arm Mount

- Accommodates different monitor weights ranging from 8.4lb to 17.8lb (3.8kg to 8.1kg)
- Compatible with VESA® 75 x 75mm and 100 x 100mm mounting patterns
- With 12.6" of height adjustment, 22" of extension adjustment, +45°/-90° of tilt, 180° of swivel and 360° of rotation
- Display can be rotated from landscape to portrait
- Cable management clips keep cables organized and out of the way



Technical Specifications

Part No.	Screen Size	Fixing Type
LCT620AD	Up to 38"	Clamp base
LCT620AD-G	Up to 38"	Grommet base

Universal Tablet Cradle



- Adjustable height and width, providing a universal fit for most tablets
- Easily attaches to any 75 x 75mm VESA® mount
- Stylish cover for improved aesthetics
- Available in Black to complement tablet design

Technical Specifications

Part No.	Max. weight	Finish
PTM200	2.27kg (5lbs)	Black

Universal desktop Tablet Mount



- Adjustable height and width, providing a universal fit for most tablets
- Stylish cover for improved aesthetics
- ±30° of One-Touch™ tilt and swivel
- 360° of roll enables move from landscape to portrait orientation
- Option to lock in place with theft resistant security screws (ACC954)
- Available in black or white (-W) finish to complement tablet aesthetics

Technical Specifications

Part No.	Max. weight	Finish
PTM400	2.27kg (5lbs)	Black/White
PTM400S	2.27kg (5lbs)	Black/White



Desktop Mount for Single Screens

- Desk clamp & grommet mount option
- Aluminium cast arm provides sturdy and durable support
- ±40° tilt
- 180° swivel
- 360° roll
- Height adjustable 320mm (12.6") on post
- Cable management clips keep cables out of the way
- **VESA® 75, 100**



Technical Specifications

Part No.	Screen Size	Max. weight
LCT100S	12-30"	9kg (20lbs)

Desktop Swivel Mount for up to 47" Displays

- Secure, functional and sleek desktop mount for hospitality applications
- Built-in swivel up to 360° allows for optimum viewing angle
- Base stand bolts down for safety and security
- Adjustable height allows for greater flexibility
- Cable management internally through the mount and down through the mounting surface
- Security screws prevent tampering and theft
- **VESA® 200 x 100, 200 x 200**



Technical Specifications

Part No.	Screen Size	Max. weight
HP447	32-47"	34kg (75lbs)

Desktop Swivel Mount for up to 55" Displays

- Secure, functional and sleek desktop mount for hospitality applications
- Built-in swivel up to 360° allows for optimum viewing angle
- Base stand bolts down for safety and security
- Adjustable height allows for greater flexibility
- Cable management internally through the mount and down through the mounting surface
- Security screws prevent tampering and theft
- **Up to VESA® 400 x 400**



Technical Specifications

Part No.	Screen Size	Max. weight
HP455	32-55"	34kg (75lbs)

Ceiling Mounts For Flat Panel Screens



These Multi Display Ceiling Mounts include telescoping arms to hold multiple displays evenly spaced in a circular configuration, helping you create a solution that can be viewed from any position. Adjustable depth on each arm allows the installer to set the spacing between each display to meet any application requirements.

- Universal mount fits displays with mounting patterns up to 730 x 405mm
- Includes 0° to 20° of tilt and 360° of swivel at time of installation for ideal display placement and viewing angle
- Arms telescope allow for the desired display spacing, either seamlessly aligned edge-to-edge or with consistent spacing between
- Independent display swivel $\pm 20^\circ$ for perfect positioning
- Bottom cover provides aesthetically pleasing finish when viewed from below and includes effective cable management
- Compatible with an extensive line of Peerless-AV ceiling plates & columns

INDEPENDENT DISPLAY SWIVEL

Each display swivels $\pm 20^\circ$ for perfect positioning

ADJUSTABLE VIEWING ANGLE

0° to 20° of tilt provide the perfect viewing angle

ADJUSTABLE DISPLAY SPACING

Telescopic arms adjust with the display width

TRIPLE AND HEXAGONAL

Options also available

SUPERIOR AESTHETICS

Bottom cover hides cables from view

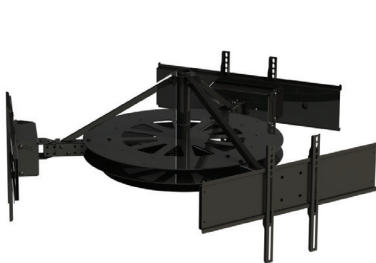
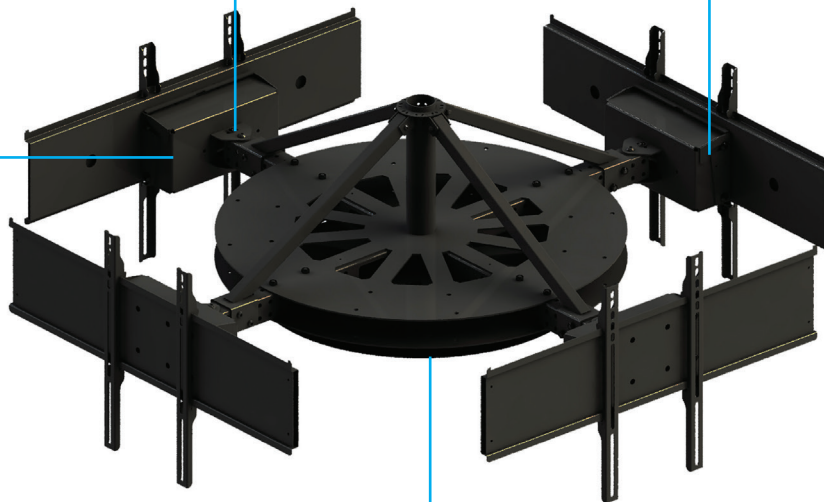

DST980-3 (Ceiling mount - 3 Displays)



DST975-4 (Ceiling mount - 4 Displays)

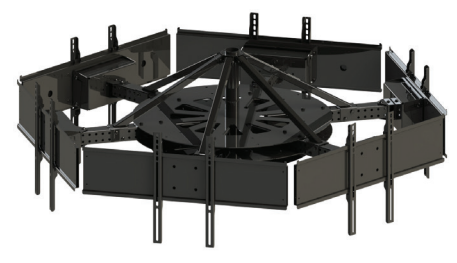

DST942-6 (Ceiling mount - 6 Displays)

Technical Specifications

Part No.	Screen sizes	Max. weight	Colour	Tilt	Mounting Pattern
DST980-3	37-80"	225kg (495lbs)	Black	0° - +20°	Universal up to 730 x 405mm
DST975-4	37-75"	227kg (500lbs)	Black	0° - +20°	Universal up to 730 x 405mm
DST942-6	37-42"	218kg (480lbs)	Black	0° - +20°	Universal up to 730 x 405mm

Dual Display Swivel Ceiling Mount

- Ideal for twin screen digital signage applications from a single column
- Independent swivel and tilt allows each display to be set at the perfect viewing angle
- Included universal adaptor plate will accommodate most displays in the 40"-70" range
- Compatible with an extensive line of Peerless-AV ceiling plates & columns
- Simple hook on display attachment makes set-up quick and easy

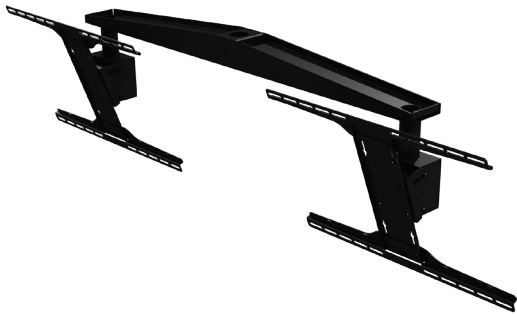

Technical Specifications				
Part No.	Screen Size	Colour	Max. weight	Mounting pattern
DST970X2	40-70"	Black	113kg (250lbs)	VESA up to 600x400mm

Back-2-Back Display Ceiling Mount

- Holds two 40" to 65" displays back-to-back at a 20° fixed tilt angle
- Removable Side panels conceal media players & cables
- Two shelves provide storage for standard size computers
- Cables are routed through the mount and column
- Comes fitted with universal mounting brackets for mounting patterns up to 730 x 405mm
- Included security hardware to deter tampering and loss
- Compatible with an extensive line of Peerless-AV ceiling plates & columns



Technical Specifications				
Part No.	Screen Size	Colour	Max. weight	Mounting pattern
DST965	40-65"	Black	136kg (300lb)	VESA up to 700x400mm

Universal Ceiling Mount

- Fits 43" to 90"+ displays with up to 600 x 400mm mounting patterns
- Mounts to wood stud or concrete, offers versatile display placement options
- Cathedral ceiling plate can attach to 0° to 90° angled ceiling structures
- Adjustable extension column provides 39.59" to 63.21" (1006 to 1606mm) of vertical adjustment
- Hook-and-Hang™ Installation. Display is easily installed by a single person
- Accommodates 100, x 100 to 600 x 400mm VESA® mounting patterns
- 360° of rotation creates endless viewing possibilities from anywhere in the room
- Locking tilt. Easily adjust your viewing angle up to +20°/-5° tilt



Technical Specifications				
Part No.	Screen Size	Colour	Max. weight	Mounting pattern
PCM150	43" to 90"+	Black	68kg	up to 600 x 400mm

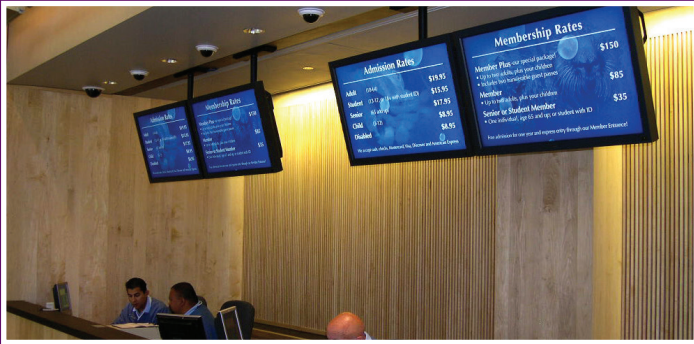

Peerless-AV offers a comprehensive range of ceiling mounts for projectors and flat panel screens in commercial and residential applications. In addition to the UK designed 'Modular Series' there is a dedicated range of Peerless-AV Professional solutions to provide added choice and versatility in any installation.

A selection of ceiling plates engineered for specific ceiling types are coupled to extension poles with threaded ends for quick and secure engagement. The system is completed by a range of adaptor & mounting solutions for projectors as well as single or dual flat panel screens, along with accessories to add the finishing touches.

Refer to the chart below for a quick reference selection guide.

EXTENSION FROM CEILING

Standard Ceiling Plate		Anti Vibration Ceiling Plates	
ACC570 Max. weight 68kg (150lbs)	ACC560 Max. weight 22kg (49lbs)	ACC840 For wood joist ceiling Max. Weight 27kg (60lbs)	ACC845 For Unistrut ceiling Mounts to 41x41mm Unistrut
ACC-CCP(HD) Standard ACC-CCP 68kg (150lbs) max. Heavy duty ACC-CCPHD 227kg (500lbs) max.	CMJ470/480/490 CMJ470: 16" joist centres CMJ480: 20" joist centres CMJ490: 24" joist centres All models 136kg (300lbs) max.		

I-BEAM/TRUSS AND UNISTRUT APPLICATIONS

I-beam/Truss Adaptors		Unistrut Plates	
ACC558/559 ACC558: 102-204mm (4-8") I beams ACC559: 178-305mm (7-12") I beams Both models 113kg (250lbs) max.		CMJ300/310 For Unistrut 102mm (CMJ300) or 203mm (CMJ310) spacing between slots. Max. weight 113kg (249lbs)	ACC550 Mounts to 41x41mm Unistrut. Max. weight 113kg (250lbs)
ACC557 Round, square, rectangular or I-beam truss up to 76x76mm, 544kg (1200lbs) max.	DCT100 Round, square, rectangular or I-beam truss up to 76x76mm, 136kg (300lbs) max.		

NOTE: Please ensure your selected ceiling plate will accommodate the combined load of all equipment & mount components

EXTENSION POLE

Adjustable

Part no.	Extension length	Part no.	Extension length
AEC006009(-S)(-W)	152-228mm (6"-9")	AEC0406(-S)(-W)	1.22-1.83m (4'-6')
AEC009012(-S)(-W)	228-304mm (9"-12")	AEC0507(-S)(-W)	1.52-2.13m (5'-7")
AEC012018(-S)(-W)	304-457mm (12"-18")	AEC0608(-S)(-W)	1.83-2.44m (6'-8")
AEC018024(-S)(-W)	457-609mm (18"-24")	AEC0810(-S)(-W)	2.44-3.05m (8'-10")
AEC0203(-S)(-W)	609-914mm (2'-3")	AEC1012(-S)(-W)	3.05-3.66m (10'-12")
AEC0305(-S)(-W)	914mm-1.52m (3'-5")		

PROJECTOR MOUNT

PRG-UNV Max. weight : 22kg (50lbs) Pitch +15/-20°, Swivel 360°, Roll ±10° Universal mounting pattern up to 448mm	PRGS-UNV Max. weight : 22kg (50lbs) Pitch +15/-20°, Swivel 360°, Roll ±5° Universal mounting pattern up to 448mm
PJF2-UNV Max. weight : 22kg (50lbs) Pitch ±15°, Swivel 360°, Roll ±5° Universal mounting pattern up to 448mm	PJR125-EUK / PJR125-POR-EUK Max. weight : 57kg (125lbs) Universal adaptor plate extends up to a 648mm mounting pattern to accommodate most projectors

DISPLAY MOUNTING BRACKETS

PLCM-2 For single flat panel display Screen size Up to 90" Max Weight 68kg (150lbs) Swivel / Pitch 360° / 20°	PLB-1 For back-to-back dual flat panel displays Screen size Up to 90" Max Weight 136kg (300lbs) Swivel / Pitch 360° / 20°
--	--

DISPLAY ADAPTOR PLATE

PLP-UNM Medium universal I-frame adaptor plate Screen size : 22-50" Max Weight : 68kg (150lbs) Mounting Pattern : Up to 400 x 400mm	PLP-UNL Large universal I-frame adaptor plate Screen size : 32-90" Max Weight : 68kg (150lbs) Mounting Pattern : Up to 600 x 400mm
--	---

Part Nomenclature

Peerless-AV use a consistent and logical part numbering system to assist customers in understanding the individual features and specifications of any model within a range or product category.

MOUNTS

Product Line	Functionality	Orientation	Surface	Display Size	Suffix
S Smart Mount	F Flat	L Landscape	4 Desktop	xx 65 (65")	S Silver
P Peerless-AV Pro (Paramount)	T Tilt	P Portrait	5 Trolley/Stand/Pedestal	Vxxx VESA (2x2, 4x4, 6x2 etc)	W White
H/HP Hospitality	A Articulating	Example: SF650P: S Smart Mount F Flat 6 = Wall (Flat) 50" Display Size P Phillips Head	6 Wall (Flat/Tilt)	UNL Universal Large	L Locking
MIS Custom (Miscellaneous)	P Pivot/Swivel		7 Wall (Pull-out/Articulating)	UNV Universal	S Security (optional)
SU Ultra Thin	X Attachment/Holder/Cover		8 Corner		P Phillips head
LCT Small Monitor (table/desk)	L Lock-down		9 Ceiling		PU Phillips screws/universal
PLP Peerless-AV Plate (display adapter)					

DIGITAL SIGNAGE MOUNTS

Product Line	Functionality	Surface	Display Size	Suffix
DS Digital Signage	C Cart (Trolley)	2 Other/Misc. (Column Shelf)	xx 65 (65")	LAND Landscape
	S Stand	5 Trolley / Stand		LQR Landscape quick release
	MBZ Menu Board	6 Wall (Flat/Tilt)		PQR Portrait quick release
	VW Video Wall	7 Wall (Pull-out/Articulating)		QR Quick release
	VWT Video Wall (Tilt)	8 Corner		S Slim
	VWS Video Wall Spacer	9 Ceiling		
	VWRS Video Wall Reusable Spacer			

dvLED MOUNTING SOLUTIONS

Functionality	Type	Size	Configuration / Display Size
LED LED	TK Trim Kit	S Small	xxXx Mount Configuration
	UNV Universal	M Medium	
	MT Mobile Trolley	L Large	
	FS Free Standing		
	BD Bolt Down		
	FC Floor-to-Ceiling		
	FW Floor-to-Wall		

Example:
LEDMTS-5X5:
LED = Functionality
MT = Mobile Trolley
S = Small (Size)
5x5 = Configuration

KIOSKS (K)



Environment	Orientation	Design	Revision	Surface	Display Size	Other	Market
I Indoor	L Landscape	H Hourglass	2 2nd gen	4 Desktop	xx Display Size	B Back to back	EUK EMEA Model
O Outdoor	P Portrait	C Curved corner	3 3rd gen	5 Stand/Pedestal		XHB Xtreme display	
						OHF Samsung display	
						LGE LG Display	
						3 3" depth display	

TROLLEYS & STANDS

Type	Rolling or Static	Series Number	Display Size	Shelf	Other
S SmartMount	R Rolling	5	xx Display Size	Null No shelf inc	-M Motorised
P Paramount	S Static	8		M Metal shelf	W White
VCM Video Conference					K Kiosk Style (half height)
					-EUK EMEA Only Product



 peerless-av.eu.com
 +44 (0) 1923 200 100
 sales@peerless-av.co.uk

 X: @PeerlessAVEU
 LinkedIn: Peerless-AV EMEA
 Vimeo: PeerlessAVEMEA

© 2026 Peerless Industries, Inc. All rights reserved. E&OE. LIT-1125

Peerless-AV constantly strive to develop new products & improve existing ones. We therefore reserve the right to change or revise product designs, specifications and model numbers without notice. All brands, product names and taglines are trademarks or registered trademarks of their respective owners.

