

\* All images used are for illustrative purposes only.



Download  
LG C-Display+  
Mobile App  
Google Play Store

- [www.lg.com/global/business/information-display](http://www.lg.com/global/business/information-display)
- [www.youtube.com/c/LGCommercialDisplay](https://www.youtube.com/c/LGCommercialDisplay)
- [www.facebook.com/LGInformationDisplay](https://www.facebook.com/LGInformationDisplay)
- [www.linkedin.com/company/lginformationdisplay](https://www.linkedin.com/company/lginformationdisplay)
- [twitter.com/LG\\_ID\\_HQ](https://twitter.com/LG_ID_HQ)



LG may make changes to specifications and product descriptions without notice.  
Copyright © 2022 LG Electronics Inc. All rights reserved. "LG Life's Good" is a registered trademark of LG Corp.  
The names of products and brands mentioned here may be the trademarks of their respective owners.

2026 GLOBAL

# LG DIGITAL SIGNAGE

Commercial Displays and Solutions



\* All images are intended to help you understand, and there may be some differences in practical use.



WELCOME TO OUR SHOPPING MALL

20% OPENING DISCOUNT

FOREST PRINCESS  
LG LED Cinema

CINEMA

PREVIOUS SEASON SALE

GIFT TO YOUR GRATEFUL

1 FLOOR GUIDE

- 1F. CLOTHING STORE
- 2F. RESTAURANT
- 3F. GYM
- 4F. BOOKSTORE
- 5F. SPA
- 6F. GARDEN

BUS

BUS STATION

SPECIAL EVENT SALE

TO SHINE YOUR WRIST

A CAR FOR SPECIAL PERSON LIKE YOU

**Shape Immersive Moments.  
Share Innovative Experience.**

Believe your business should be more impactful and iconic. LG is here to realize the true potential of your business. Display all your boundless ideas on digital signage and watch the technology of LG shapes them into immersive moments. Make your ideas more outstanding through reality and vividness beyond your imagination and interactivity that allows people to engage. All immersive moments combine to create innovative experience for your business.

---

# CONTENTS

---

## LG Digital Signage Introductions

- LED
  - OLED
  - High Brightness
  - One:Quick
  - Interactive Digital Board
  - Video Wall
  - Stretch
  - UHD
  - FHD
  - Special
  - webOS Smart Signage Platform
  - SuperSign Solution
  - Extended Care
- 

## LED

Various Designs for Customer's Demands,  
Offers Great Visual Effects Through High Durability

---

LG boasts unprecedented visual performance and stability by expanding its industry-leading display technology to LED signage. LG also has a variety of lineups to offer customized solutions in the indoor/outdoor environment.

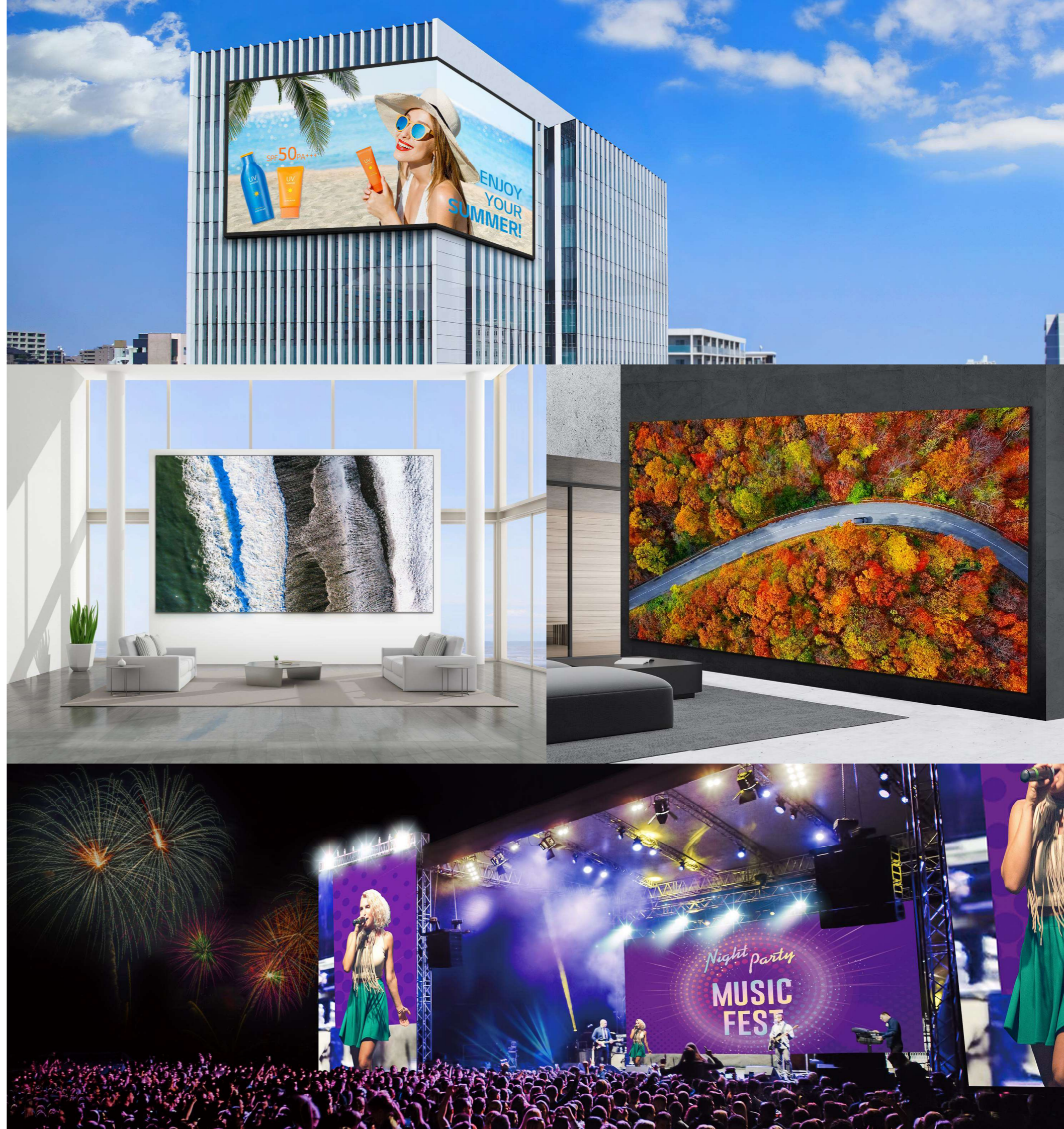

LED LINE UP

**LG MAGNIT LSAH Series**

**LSAH** | P0.78



- Pixel Pitch : 0.78 mm
- Brightness : 1,700 nit (Peak), 300 nit (Max)
- Active Micro LED Display
- Contrast Ratio (10 lux) : 1,000,000 : 1

\* Based on LSAH007 Specification

**LG MAGNIT LSAP Series**

**LSAP** | P0.78 P0.94 P1.25



- Pixel Pitch : 0.78 mm
- Brightness : 600 (min.)
- Power UI/UX with Megapixel HELIOS LED Processing Platform
- Black Immersion
- Accurate Colors
- IP Rating : IP50 / IP20 (Front / Rear)

\* Based on LSAP007 Specification

**LG MAGNIT LMPA Series**

**LMPA** | P0.93



- Pixel Pitch : 0.93 mm
- Brightness : 1,500 nit (Peak), 600 nit (Typ.)
- Micro LED Display
- Frame Rate (Hz) : 50 / 60
- Contrast Ratio (10 lux) : 40,000 : 1 @10lux (TBD)
- Enhanced User Experience

\* Based on LMPA009 Specification

**LG MAGNIT LAAA Series**

**LAAA** | P0.78 P0.94 P1.56

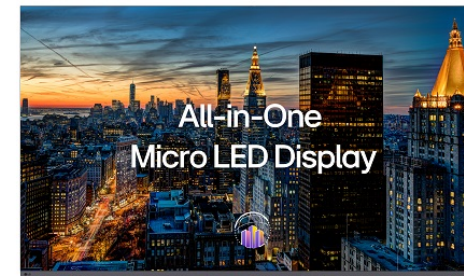

- Pixel Pitch : 0.78 mm
- Screen Size: 136" (Ultra HD)
- Max. Brightness (After Calibration) : 500 nit
- Achieving Deep Black
- Intelligent Processor
- Embedded System Controller and Built-in Speaker

\* Based on LAAA007 Specification

**LG MAGNIT LMPB Series**

**LMPB** | P0.78 P0.93



- Pixel Pitch : 0.78 mm
- Brightness : 1,000 nit (Peak), 500 nit (Typ.)
- Micro LED Display
- Frame Rate (Hz) : 96 / 100 / 120
- Contrast Ratio (10 lux) : 20,000 : 1
- Enhanced User Experience

\* Based on LMPB007 Specification

**LG MAGNIT LBAG Series**

**LBAG** | P1.56



- Pixel Pitch : 1.5 mm
- Brightness : Max. 1,500 nit
- Power UI/UX with Megapixel HELIOS LED Processing Platform
- Easy Installation and Maintenance
- Curve Effect Available
- Stacking & Hanging System Available

\* Based on LBAG015 Specification

LED LINE UP

**LG MAGNIT LBAF Series**

**LBAF** | P1.56



- Pixel Pitch : 1.56 mm
- Brightness : 1,500 nit
- Easy Installation and Maintenance
- Curve Effect Available
- Stacking & Hanging System Available
- Black Immersion

\* Based on LBAF015 Specification

**LG Miraclass LDAA-1 Series**

**LDAA-1** | P2.50



- Pixel Pitch: 2.5 mm
- Screen Size: 5.1 m x 2.7 m (14 sqm)
- Screen Resolution: 2,048 x 1,080 px
- Brightness : 48(DCI) / 55 / 65 / 75 / 100 / 130 / 260 / 300 nit
- 3D Support, Dolby Media Server Compatible

\* Based on LDAA025-1 Specification

**LG MAGNIT LSAB Series**

**LSAB** | P0.78 P0.9 P1.25

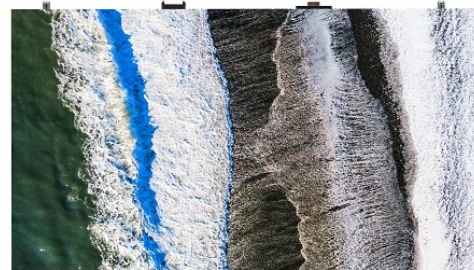

- Pixel Pitch : 0.78 mm
- Brightness : 1,000 nit (Peak), 500 nit (Max)
- Micro LED Display
- Chip on Board Technology
- Contrast Ratio (10 lux) : 20,000 : 1
- Cable-less Signal Transmission & Power Docking

\* Based on LSAB007 Specification

**LG Miraclass LDAA Series**

**LDAA** | P2.50

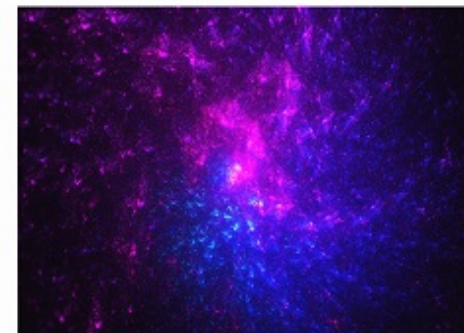

- Pixel Pitch: 2.5 mm
- Screen Size: 10.2 m x 5.4 m (55 sqm)
- Screen Resolution: 4,096 x 2,160 px
- Brightness : 48(DCI) / 55 / 65 / 75 / 100 / 130 / 260 / 300 nit
- 3D Support, Dolby Media Server Compatible

\* Based on LDAA025 Specification

**LG Miraclass LDAA Series**

**LDAA** | P1.25



- Pixel Pitch: 1.25 mm
- Screen Size: 5.1 m x 2.7 m (14 sqm)
- Screen Resolution: 4,096 x 2,160 px
- Brightness : 48(DCI) / 55 / 65 / 75 / 100 / 130 / 260 / 300 nit
- 3D Support, Dolby Media Server Compatible

\* Based on LDAA012 Specification

**LG Miraclass LADF Series**

**LADF** | P3.3



- Pixel Pitch: 3.3 mm
- Screen Size: 14.1 m x 7.2 m (101 sqm)
- Screen Resolution: 4,224 x 2,160 px
- Brightness: 48(DCI) / 55 / 65 / 75 / 100 nit
- 3D Support, Dolby Media Server Compatible

\* Based on LAD033F Specification

LED LINE UP



**Virtual Production LED LBCG Series**

**LBCG** | P2.60

- Pixel Pitch: 2.60 mm
- Brightness: 1,500 nit
- Easy Installation and Maintenance
- Stacking & Hanging System Available
- Service Access : Front or Rear (Select One Only)
- IP Rating : IP30 / IP30 (Front / Rear)

\* Based on LBCG026 Specification



**Virtual Production LED LFCL Series**

**LFCL** | P3.91

- Pixel Pitch: 3.91mm
- Brightness: 3,000 nit
- High Durability
- Excellent Usability
- Easy Installation and Maintenance
- Brompton LED Processor & Data Distribution

\* Based on LFCL039 Specification



**Virtual Production LED GSCE Series**

**GSCE** | P3.91

- Pixel Pitch: 3.91 mm
- Brightness: 5,000 nit
- Easy Installation and Maintenance
- High Brightness
- Service Access : Front or Rear (Select One Only)
- IP Rating : IP30 / IP30 (Front / Rear)

\* Based on GSCE039 Specification



**Virtual Production LED LBAE Series**

**LBAE** | P2.60

- Pixel Pitch: 2.60 mm
- Brightness: 1,500 nit
- Easy Installation & Maintenance
- Curve Effect Available
- Stacking & Hanging System Available
- Broadcast Quality Available

\* Based on LBAE026 Specification

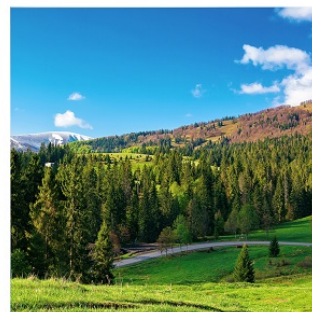

**Virtual Production LED LFCM Series**

**LFCM** | P3.91

- Pixel Pitch: 3.91 mm
- Brightness: 1,500 nit
- High Durability
- Excellent Usability
- Easy Installation and Maintenance
- Power UI/UX with Megapixel VR HELIOS LED Processing Platform

\* Based on LFCM039 Specification

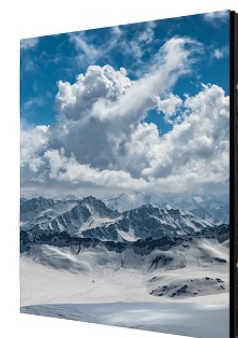

**Virtual Production LED LBCJ Series**

**LBCJ** | P2.60

- Pixel Pitch: 2.60 mm
- Brightness: 1,500 nit
- Easy Installation & Maintenance
- Curve Effect Available
- Broadcast Quality Available
- Brompton LED Processor & Data Distribution

\* Based on LBCJ026 Specification

LED LINE UP

**Virtual Production LED LBCK Series**



**LBCK** | P3.91

- Pixel Pitch: 3.91 mm
- Brightness: 5,000 nit
- Easy Installation & Maintenance
- Front or Rear Serviceability
- Brompton LED Processor & Data Distribution

\* Based on LBCK039 Specification

**Indoor LG LED All-in-One Series**

**LABA** | P1.58

FHD Resolution configuration case

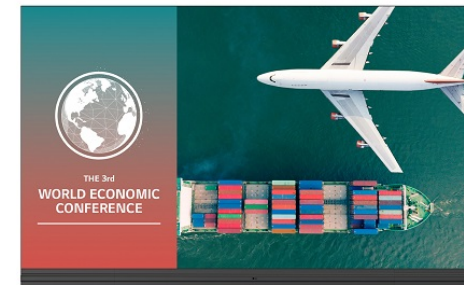

- \*Below for FHD resolution configuration case
- Pixel Pitch : 1.58 mm
- Brightness 500 nit (Max., after calibration)
- Easy Installation and Maintenance
- Built-in Speaker & a Control Box

\* Based on LABA015 Specification

**Indoor LG LED All-in-One Series**

**LABB** | P1.58

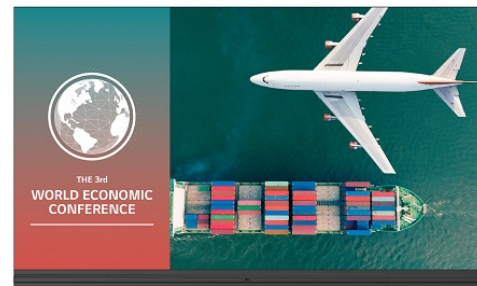

- Pixel Pitch : 1.58 mm
- Brightness : 500 nit (Typ., After Calibration)
- Screen Resolution : 1,920 x 1,080
- Service Access : Front

\* Based on LABB015 Specification

**Indoor LG LED All-in-One Series**

**LAED** | P1.56



- Pixel Pitch : 1.56 mm
- Screen Size: 171"
- 21:9 Widescreen
- Embedded System Controller and Built-in Speaker
- Brightness (after calibration) : 500 nit (Max.)

\* Based on LAED015 Specification

**Indoor LG LED All-in-One Series**

**LAPA** | P1.56 P1.88



- Screen Size : 136"
- Pixel Pitch : 1.56 mm
- Brightness : 500 nit (Max., after calibration)
- Screen Resolution : 1,920 x 1,080

\* Based on LAPA136 Specification

**Indoor LG LED All-in-One Series**

**LAEC** | P1.56 P1.88

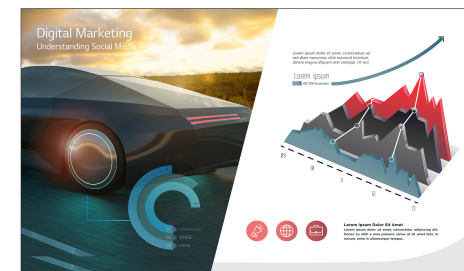

Compatible with **LG One:Quick** Share

- Pixel Pitch: 1.56 mm
- Screen Size: 136" (Full HD)
- Brightness: 500 nit (Max., after calibration)
- Embedded System Controller
- Built-in Speaker
- Dedicated Accessories : Wall Mount, Dedicated Stand (Optional)

\* Based on LAEC015-GN2 Specification

LED LINE UP

**Transparent Film LTAK Series**

**LTAK-GU** | P14.00

- Pixel Pitch : 13.7 ± 0.2 mm (14)
- LED Type : R, G, B 3 in 1 Color Package
- Brightness : 1,000 nit (Typ.)
- Transmittance : 60% (Typ.)



\* Based on LTAK140-GU Specification

**Indoor LED LSCD Series**

**LSCD** | P1.25 P1.56

- Pixel Pitch : 1.25 mm
- Brightness : 800 nits (Max., After Calibration)
- Service Access : Front
- IP Rating : IP30 (Front / Rear)



\* The image above may differ from the actual appearance.

\* Based on LSCD012 Specification

**Indoor LED LMEA Series**

**LMEA** | P1.25

- Pixel Pitch : 1.25 mm
- Brightness : 600 nits (Max., After Calibration)
- Service Access : Front
- IP Rating (Front / Rear) : IP50 / IP20

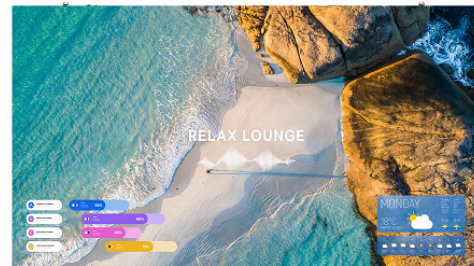

\* Based on LMEA012 Specification

**Indoor LED LSCC Series**

**LSCC** | P1.25 P1.56 P1.88 P2.5

- Pixel Pitch: 1.25mm
- Brightness: 800 nit (Max.)
- Ultra Slim Depth and Lightweight
- Flexible Design

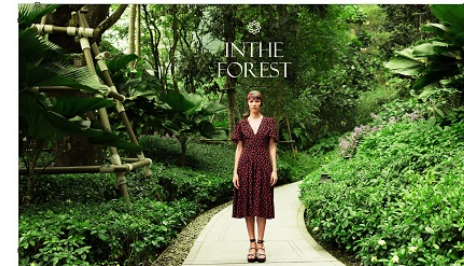

\* The image above may differ from the actual appearance.

\* Based on LSCC012 Specification

**Virtual Production LED LBPA Series**

**LBPA** | P1.95

- Pixel Pitch : 1.95 mm
- Brightness : 1,500 nits
- Service Access : Front and Rear
- IP Rating : IP30



\* Based on LBPA019 Specification

**Indoor LED LSGA Series**

**LSGA** | P1.85 P2.6 P3.91

- Pixel Pitch : 1.85 mm
- Brightness : 800 nit
- Fast Installation
- Easy Maintenance
- Front and Rear Serviceability
- IP Rating : IP40 / IP20 (Front / Rear)



\* Based on LSGA018 Specification

LED LINE UP

**Indoor LED LSBE Series**

**LSBE** | P1.25 P1.56 P1.88 P2.50



- Pixel Pitch : 1.25 mm
- Brightness : 600 nit
- Easy Installation and Maintenance
- Durable Frame Design
- Compatibility with LG Software Solutions
- IP Rating : IP50 / IP50 (Front / Rear)

\* Based on LSBE012 Specification

**Indoor LED LWBC Series**

**LWBC** | P2.60 P2.98 P3.91



- Pixel Pitch: 2.60 mm
- Brightness: 3,500 nit
- Slim Bezel
- Long-lasting High Performance
- Quick Lock & Flip Design
- Front or Rear Serviceability

\* Based on LWBC026 Specification

**Indoor LED LCCM Series**

**LCCM** | P1.90 P2.50



- Pixel Pitch: 1.90 mm
- Brightness: 800 nit
- Creative LED Screen
- Easy Installation and Maintenance
- Compatibility with LG Software Solutions

\* Based on LCCM019 Specification

**Indoor LED LSBF Series**

**LSBF** | P1.25 P1.56 P1.88 P2.50



- Pixel Pitch : 1.25 mm
- Brightness : 600 nit
- Easy Installation and Maintenance
- Durable Frame Design
- Compatibility with LG Software Solutions
- IP Rating (Front / Rear) : IP50 / IP50

\* Based on LSBF012 Specification

**Indoor LED LFCG Series**

**LFCG** | P3.91



- Pixel Pitch: 3.91 mm
- Brightness: 1,500 nit
- High Durability
- Excellent Usability
- Easy Installation and Maintenance
- IP Rating: IP65

\* Based on LFCG039 Specification

**Indoor LED LSCB Series**

**LSCB** | P1.25 P1.56 P1.88 P2.50



- Pixel Pitch: 1.25mm
- Brightness: 800 nit (Max.)
- Ultra Slim Depth
- EMC Class B, BS 476 Part7 Class 1

\* The image above may differ from the actual appearance.

\* Based on LSCB012 Specification

LED LINE UP

**Outdoor LED GSPB Series**

**GSPB** | P3.91



- Pixel Pitch : 3.91 mm
- Brightness : 8,000 nit (Max.)
- Service Access : Front and Rear
- IP Rating : IP65 (Front / Rear)

\* Based on GSPB039 Specification

**Outdoor LED GEAA Series**

**GEAA** | P1.88



- Pixel Pitch : 1.88 mm
- Brightness : 3,500 nit (Max.)
- Open-frame Type
- High Reliability
- High Picture Quality
- Energy Efficiency

\* Based on GEAA018 Specification

**Outdoor LED GNPA Series**

**GNPA** | P6.25 P8.33



- Pixel Pitch : 6.25 mm
- Brightness : 6,000 nit (Max.)
- Service Access : Front and Rear
- IP Rating : IP67 / IP67 (Front / Rear)

\* Based on GNPA062 Specification

**Outdoor LED GSPA Series**

**GSPA** | P6.67 P10



- Pixel Pitch : 6.67 mm
- Brightness : 8,000 / 6,000 nit
- IP Rating : IP66 (Front / Rear)

\* Based on GSPA066 Specification

**Outdoor LED GSPC Series**

**GSPC** | P2.98

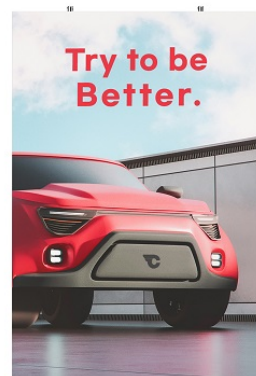

- Pixel Pitch : 2.98 mm
- Brightness : 5,500 nit
- Service Access : Front and Rear
- IP Rating : IP66 (Front / Rear)

\* Based on GSPC029 Specification

**Outdoor LED GSCF Series**

**GSCF** | P2.6



- Pixel Pitch: 2.6 mm
- Brightness: 5,500 nit (-GP) / 5,000 nit (-KK)
- Product Reliability
- Easy Maintenance
- Front or Rear Serviceability
- IP Rating : IP65 / IP65 (Front / Rear)

\* Based on GSCF026 Specification

LED LINE UP



**Outdoor Mesh LED GMBD Series**

**GMBD** | P35.00 P40.00

- Pixel Pitch: 35 mm
- Brightness: 7,500 nit
- IP Rating: IP66
- Flexibility for Various Screen Shapes
- Lightweight Mesh LED
- Easy Maintenance

\* Based on GMBD035 Specification



**Stadium LED GRPA Series**

**GRPA** | P6.25 P10

- Pixel Pitch : 6.25 mm
- Brightness : 6,000 nit (Max.)
- Service Access : Top
- IP Rating : IP65 / IP65 (Front / Rear)

\* Based on GRPA062 Specification



**Stadium LED GPPA Series**

**GPPA** | P6.25 P10

- Pixel Pitch : 6.25 mm
- Brightness : 6,000 nit (Max.)
- Service Access : Front and Rear
- IP Rating : IP65 / IP65 (Front / Rear)

\* Based on GPPA062 Specification

# OLED

## Artistic Space beyond Display

---

Beyond its informative features, LG OLED signage delivers unsurpassed advertising effectiveness, redesigning space as a prestige-enhancing landmark with perfect colors and innovative forms.



OLED LINE UP

**Transparent OLED EW5Q-C Series**

**EW5Q-C** | 55"

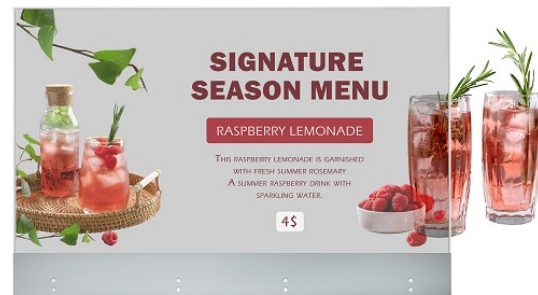

- Brightness : 200 / 600 nit (APL 100% / 25%, without Glass)
- Native Resolution : 1,920 × 1,080 (FHD)
- Contrast Ratio : 200,000 : 1

\* Based on 55EW5Q-C Specification

**Curvable OLED EF5K-P Series**

**EF5K-P** | 55"



- Brightness: 150/400nit (APL 100%/25%)
- Depth: 12.4 mm (Head Only)
- Curvature: ~1,000R(Concave/Convex)
- Interface: HDMI, DP, USB(2), Audio, RS232C, RJ45, IR

\* Based on 55EF5K-P Specification

**Transparent OLED EW5P-M Series**

**EW5P-M** | 55"



- Resolution : 1,920 × 1,080 (FHD)
- Brightness : 200 / 600 nit (APL 100% / 25%, without Glass)
- Transparency : 43% (Set)
- Bezel Width : Even 12.2mm (T/R/L/B)

\* Based on 55EW5P-M Specification

**Curvable OLED EF5K-L Series**

**EF5K-L** | 55"



- Brightness: 150/400nit (APL 100%/25%)
- Depth: 12.4 mm (Head Only)
- Curvature: ~1,000R(Concave/Convex)
- Interface: HDMI, DP, USB(2), Audio, RS232C, RJ45, IR

\* Based on 55EF5K-L Specification

**Transparent OLED EW5TP-A Series**

**EW5TP-A** | 30"



- Brightness (Typ.) : 200 / 600 nit (APL 100% / 25%, Without Glass)
- Transparency : 37% (Set)
- Bezel : 7.9 mm (T/R/L), 114.7 mm (B)
- Interface : HDMI / DP / USB 2.0 / Touch USB / RS232C / RJ45 / IR / Audio
- P-Cap Touch, Tempered Front Glass (3T)

\* Based on 30EW5TP-A Specification

**Flat OLED EJ5K Series**

**EJ5K** | 55"



- Brightness(Typ.): 150/400 nit (APL 100% / 25%)
- Bezel : 5.3 mm (T/B/L), 11.0 mm (B)
- Interface : HDMI/DP/USB(2)/ RS232C/ RJ45/ Audio/ IR

\* Based on 55EJ5K Specification

## OLED LINE UP

### OLED Pro Monitor EP5Q Series

EP5Q | 65"



- Resolution : 3,840 × 2,160 (UHD)
- Brightness : 2,900 / 2,200 / 1,000 / 330 nits (APL 3% / 10% / 25% / 100%)
- Contrast Ratio : 3,300,000 : 1
- Portrait / Landscape : No / Yes

\* Based on 65EP5Q Specification

### OLED Pro Monitor EP5G Series

EP5G | 65"



- Accurate Color with a Wide OLED Screen
- Jack Interfaces for Professional (SDI, SFP+, etc.)
- Smart Calibration
- Brightness(Typ.) : 1,000 / 900 / 500 / 180 nit (APL 3% / 10% / 25% / 100%)

\* Based on 65EP5G Specification

# HIGH BRIGHTNESS

Outstanding Visibility with Reliable Performance

With superior picture quality and excellent durability, the display's eye-catching content will captivate customers even under direct sunlight or extreme environmental fluctuations.

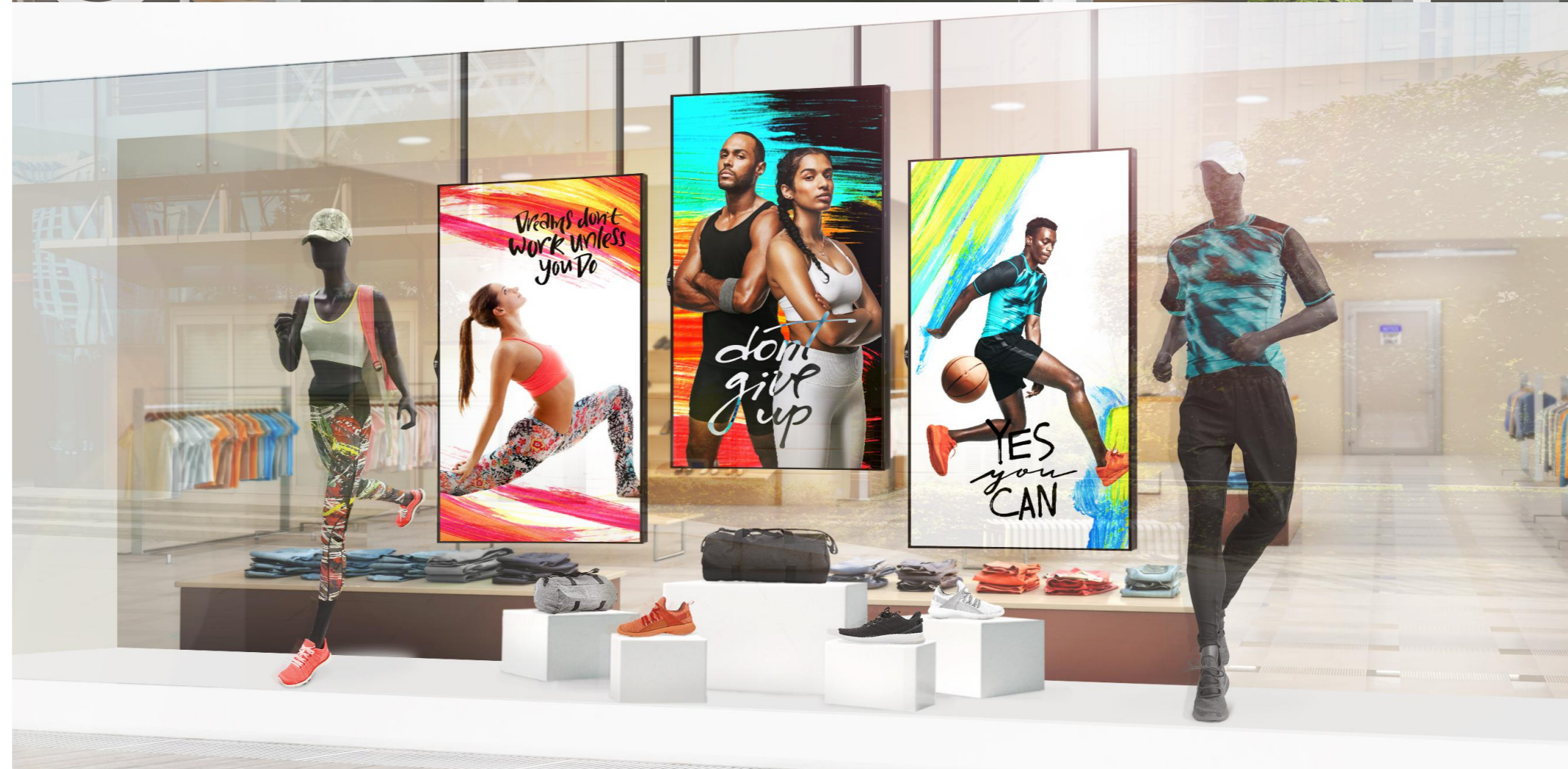
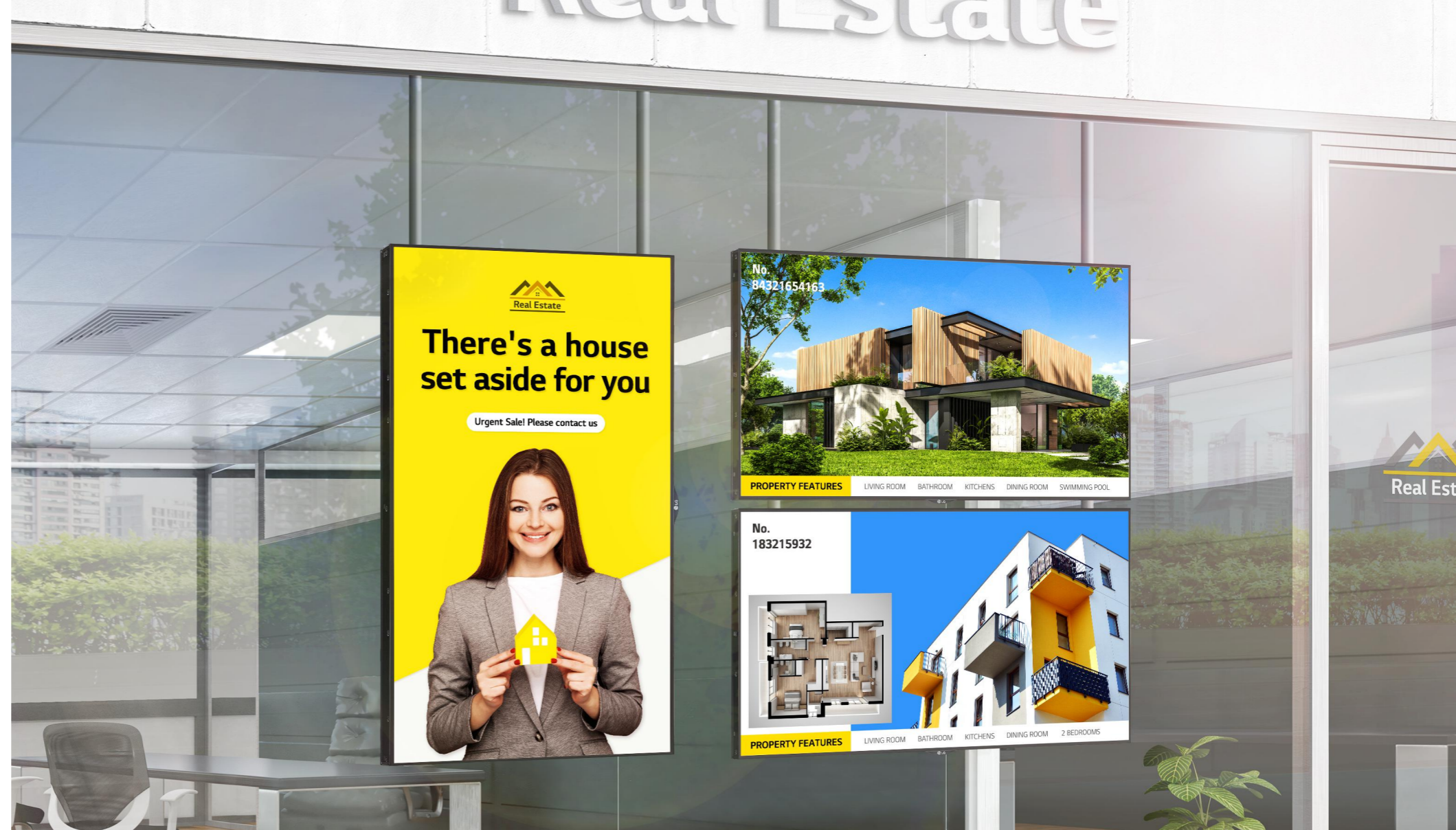

HIGH BRIGHTNESS LINE UP

**IP-rated Outdoor Display XE4P-M Series**

**XE4P-M** | 55" 49"

- UL Verified Display Anti-discoloration characteristics
- Resolution : 1,920 × 1,080 (FHD)
- Brightness : 4,000 nits (Typ.), 3,200 nits (Min.)
- Temperature Sensor
- Auto Brightness Sensor
- Support HDBaseT

\* Based on 55XE4P-M Specification

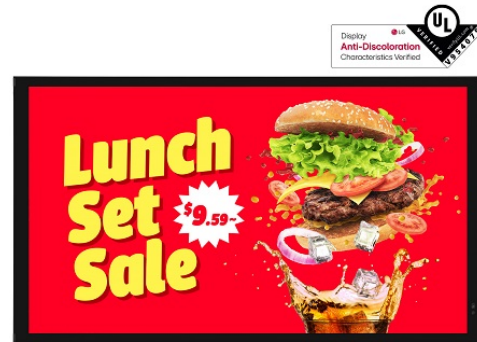

**IP-rated Outdoor Display XE3P-B Series**

**XE3P-B** | 55" 49"

- UL Verified Display Anti-discoloration characteristics
- Resolution : 1,920 × 1,080 (FHD)
- Brightness : 3,500 nits (Typ.), 2,800 nits (Min.)
- Portrait / Landscape

\* Based on 55XE3P-B Specification

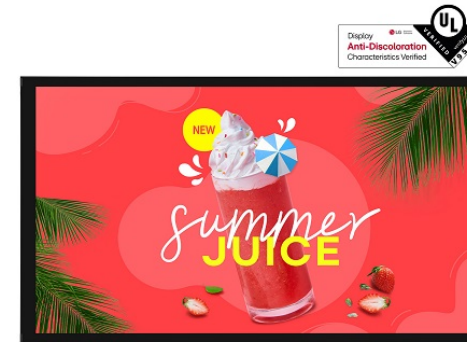

**Window Facing Display XS4P Series**

**XS4P** | 75" 55" 49"

- UL Verified Display Anti-discoloration characteristics
- Resolution : 3,840 × 2,160 (UHD)
- Brightness : 4,000 nit (Typ.), 3,200 nit (Min.)
- Portrait / Landscape
- Space Efficiency

\* Based on 75XS4P Specification



**IP-rated Outdoor Display XE1J-B Series**

**XE1J-B** | 22"

- Brightness (Typ, w/ Glass) : 1,500 nits
- IP56 Rated Dust / Water Proof
- 21.5" of Versatile Display Size
- Wide Operating Temperature Range
- webOS Smart Platform
- Web-based Monitoring Solution

\* Based on 22XE1J-B Specification



**IP-rated Outdoor Display XE4P-B Series**

**XE4P-B** | 55" 49"

- UL Verified Display Anti-discoloration characteristics
- Resolution : 1,920 × 1,080 (FHD)
- Brightness : 4,000 nits (Typ.), 3,200 nits (Min.)
- Temperature Sensor
- Auto Brightness Sensor

\* Based on 55XE4P-B Specification

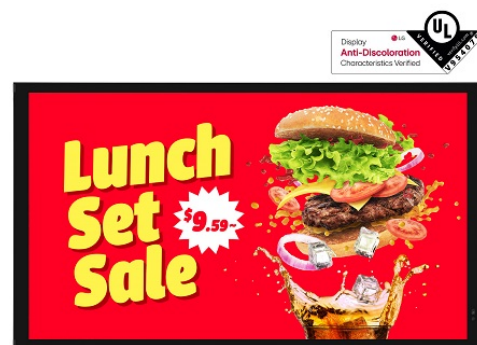

**IP-rated Outdoor Display XE4F-M Series**

**XE4F-M** | 55" 49"

- Brightness(Typ.) : 4,000 cd/m<sup>2</sup>
- Bezel : 38.4 mm (T/B), 26.0 mm (L/R)
- Interface : HDMI/ DP/HDBaseT/USB/ Audio/ RS232C/ RJ45
- Anti-Reflection Coating
- IP56 Design, IK10 Protective Glass

\* Based on 55XE4F-M Specification



HIGH BRIGHTNESS LINE UP



**IP-rated Outdoor Display XE3FS-B Series**

**XE3FS-B** | 86"

- Brightness(Typ.) : 3,000 cd/m<sup>2</sup>
- Bezel : 101 mm (T/B), 135 mm (L/R)
- Interface : HDMI/ DP/ DVI-D/ USB/ Audio/ RS232C/ RJ45/ External IR
- Anti-Reflection Coating
- IP56 Design, Protective Glass

\* Based on 86XE3FS-B Specification



**Open-frame Display XF3P Series**

**XF3P** | 75" 55"

- UL Verified Display Anti-discoloration characteristics
- Resolution : 3,840 × 2,160 (UHD)
- Brightness : 3,000 cd/m<sup>2</sup> (Typ.), 2,800 cd/m<sup>2</sup> (Min.)
- Portrait / Landscape
- Slim Design
- Conformal Coating

\* Based on 75XF3P Specification



**IP-rated Outdoor Display XE3C Series**

**XE3C** | 75"

- Brightness(Typ.) : 3,000 cd/m<sup>2</sup>
- Operating Temperature : -30°C to 50 °C
- IP56 Design
- Interface : HDMI / DP / DVI / RJ45 / RS232C / SD Card / USB3.0 / External speaker out

\* Based on 75XE3C Specification



**Open-frame Display XF3CK Series**

**XF3CK** | 86"

- UL Verified Display Anti-discoloration characteristics
- Brightness : 3,300 nits (Typ.)
- Resolution : 3,840 × 2,160 (UHD)
- Temperature Sensor
- Auto Brightness Sensor
- Smart Brightness Compensation

\* Based on 86XF3CK Specification



**Open-frame Display XF3PS Series**

**XF3PS** | 75"

- UL Verified Display Anti-discoloration Characteristics
- Resolution : 3,840 × 2,160 (UHD)
- Brightness : 3,000 nit (Typ.), 2,800 nit (Min.)
- Portrait / Landscape
- Slim Design
- Conformal Coating

\* Based on 75XF3PS Specification



**Open-frame Display XF3SK Series**

**XF3SK** | 86"

- UL Verified Display Anti-discoloration characteristics
- Brightness : 3,300 nits (Typ. w/o Glass)
- Resolution : 3,840 × 2,160 (UHD)
- Long-lasting High Performance
- Temperature Sensor
- Auto Brightness Sensor

\* Based on 86XF3SK Specification

# LG One:Quick Series

What a One:derful Life

One:Quick Works

One:Quick Flex

One:Quick Share



ONE:QUICK LINE UP

**One:Quick Works Series**

**CT5WN-B** | 55"

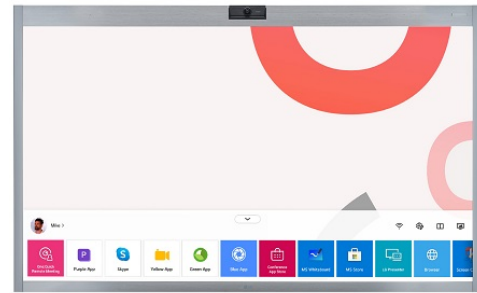

\* Screen images simulated.

- Resolution : 4K Ultra HD (3,840 x 2,160)
- Brightness : 450 nit
- Built-in 4K Camera & Microphone
- Sound (10W + 10W)
- In-Cell Touch (Max. 10 Points)
- Windows 10 IoT Enterprise (Value)

\* Based on 55CT5WN-B Specification

**One:Quick Flex Series**

**HT3WJ** | 43"



\* Screen images simulated.  
\* Stands are sold separately.

- Resolution : 4K Ultra HD (3,840 x 2,160)
- Brightness : 350 nit
- Camera : 2K Full HD (1,920 x 1,080), 88° FoV
- Sound : 2.0 Channel (10W + 10W)
- Microphone : 3m Pickup Range
- Windows 10 IoT Enterprise (Basic)

\* Based on 43HT3WJ Specification

**One:Quick Works Series**

**CT5WJ** | 55"

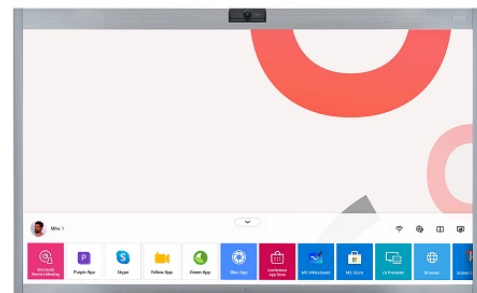

\* Screen images simulated.

- Resolution : 4K Ultra HD (3,840 x 2,160)
- Brightness : 450 nit
- Built-in 4K Camera & Microphone
- Sound (10W + 10W)
- In-Cell Touch (Max. 10 Points) & Whiteboard Support
- Windows 10 IoT Enterprise (Value)

\* Based on 55CT5WJ Specification

**One:Quick Share Series**

**SC-00DA** |



LG One:Quick Share

- Embedded OS : Linux
- Wi-Fi : IEEE 802.11 a/b/g/n/ac
- Connectivity : USB 2.0 Type A (1)
- Work together with LG One:Quick Share Application and Compatible LG digital signage models

\* Based on SC-00DA Specification

**One:Quick Flex Series**

**HT3WN-M** | 43"



\* Screen images simulated.  
\* Stands are sold separately.

- Resolution : 4K Ultra HD (3,840 x 2,160)
- Brightness : 350 nit
- Camera : 2K Full HD (1,920 x 1,080), 88° FoV
- Sound : 2.0 Channel (10W + 10W)
- Microphone : 3m Pickup Range
- Windows 10 IoT Enterprise (Basic)

\* Based on 43HT3WN-M Specification

# INTERACTIVE DIGITAL BOARD

Smart Collaboration beyond Touch Experience

The LG Interactive Digital Board (IDB) boosts meeting productivity by encouraging participants to freely share their ideas on the screen using intuitive touch and embedded collaboration solutions.



## INTERACTIVE DIGITAL BOARD LINE UP

### LG CreateBoard TR3DQ-BN Series

TR3DQ-BN | 86"



- Resolution : 3,840 × 2,160 (UHD)
- Brightness : 400 nit (Typ.)
- CPU : Octa-core A73x4 +A53x4
- Memory (RAM) : 16GB
- Storage : 256GB
- Multi-Touch Point : Max. 50 Points

\* Based on 86TR3DQ-BN Specification

### LG CreateBoard TR5WP Series

TR5WP | 105"



- Screen Size : 105"
- Resolution : 5,120 × 2,160 (5K)
- Brightness : 400 nit (Typ.) with Glass
- Multi-Touch Point : Max. 50 Points

\* Based on 105TR5WP Specification

### LG CreateBoard TR3BQ Series

TR3BQ | 86" 75" 65"

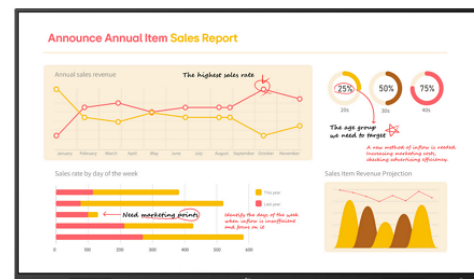

- Resolution : 3,840 × 2,160 (UHD)
- Brightness : 350 nit (Typ.)
- Multi-Touch Point : Max. 40 Points
- Interface (Input) : HDMI (3), Audio, RS-232C, RJ45 (LAN), USB 3.0 Type A (4), USB 2.0 Type A, USB Type-C
- Interface (Output) : Audio, Audio Optical (SPDIF), Touch USB (2), RJ45 (LAN)

\* Based on 86TR3BQ Specification

### LG CreateBoard TR3PN Series

TR3PN | 86" 75" 65"

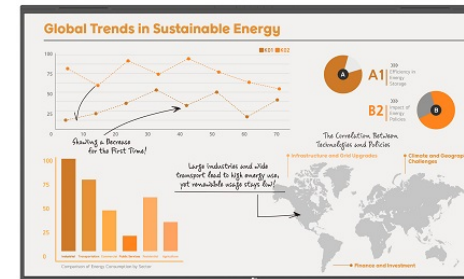

- Resolution : 3,840 × 2,160 (UHD)
- Brightness : 400 nit (Typ.)
- Multi-Touch Point : Max. 50 Points
- OS Ver. : Andorid 13
- Interface (Input) : HDMI (4, HDCP2.3), DP (1, HDCP1.3/2.3), Audio (1), RS-232C (1), RJ45 (1, LAN), USB Type-C (2), USB 3.0 Type A (4), USB 2.0 Type A (3)
- Interface (Output) : HDMI Out (1), Audio Out (1), Touch USB 2.0 Type A (2), RJ45 (1, LAN)

\* Based on 86TR3PN Specification

### LG CreateBoard TR3DQ Series

TR3DQ | 86" 75" 65" 55"



- Resolution : 3,840 × 2,160 (UHD)
- Brightness : 400 nit (Typ.)
- Multi-Touch Point : Max. 50 Points
- OS Ver. : Andorid 14 (EDLA)
- Interface (Input) : HDMI (3), DP, RGB (VGA), Audio, RS-232C, RJ45 (LAN), USB Type-C (2), USB 3.0 Type-A (5), USB 2.0 Type-A
- Interface (Output) : HDMI Out, Audio Out, Touch USB (3), RJ45 (LAN)

\* Based on 86TR3DQ Specification

### LG CreateBoard TR3DK-BM Series

TR3DK-BM | 98" 86" 75" 65" 55"



- Internal Memory : 64GB (Storage) / 8GB (RAM)
- Brightness (w/o Glass) : 440 nit (Max.), 390 nit (Typ.)
- Resolution : 3,840 × 2,160 (UHD)
- Multi-Touch Point : 40 Points (Max.)

\* Based on 98TR3DK-BM Specification

## INTERACTIVE DIGITAL BOARD LINE UP

**Built-in Touch Signage TC3CG-H Series****TC3CG-H** | 55"

- Brightness : 350nit (w Glass, typ)
- Multi Touch Point : 40 Points (Max.)
- Interface (Input) : HDMI (2, HDCP 2.2/1.4), DP (1, HDCP2.2/1.3), RS-232C In, RJ45 (LAN), IR In, USB2.0 Type A (2)
- Interface (Output) : DP Out (1, Input HDMI1/2/DP/OPS), Audio Out, External Speaker Out (6 ohm), Touch USB (USB 2.0 Type B), RS-232C Out

\* Based on 55TC3CG-H Specification

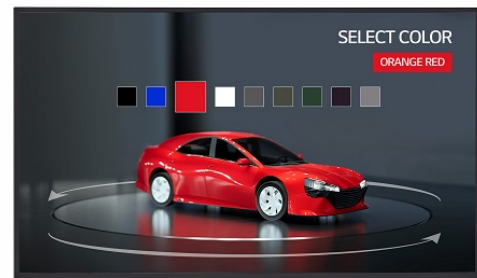
**Touch Open Frame TNF5P Series****TNF5P** | 55" 43" 32"

- Brightness : 450 nit
- Multi Touch Point : 10 Points (Max.)
- Interface : HDMI (2, HDCP 2.2/1.4), RS-232C In, RJ45(LAN), IR In, USB2.0 Type A, Audio Out, Touch USB (USB 2.0 Type B)

\* Based on 55TNF5P Specification

**Touch Open Frame TNF3K Series****TNF3K** | 27"

- 27" Full HD Touch Display
- Brightness : 300 nit
- Multi-Touch Point : Max. 10 Points
- Interface : HDMI (2) / RS-232C / RJ45 / IR / USB 2.0 Type A / Audio / Touch USB (USB 2.0 Type B)

\* Based on 27TNF3K Specification

# VIDEO WALL

Artistic Immersion, Overwhelming Captivation

Seamlessly assembled on a large video wall screen, the impressive immersion generated by LG's extremely narrow bezel provides an extraordinary viewing experience.

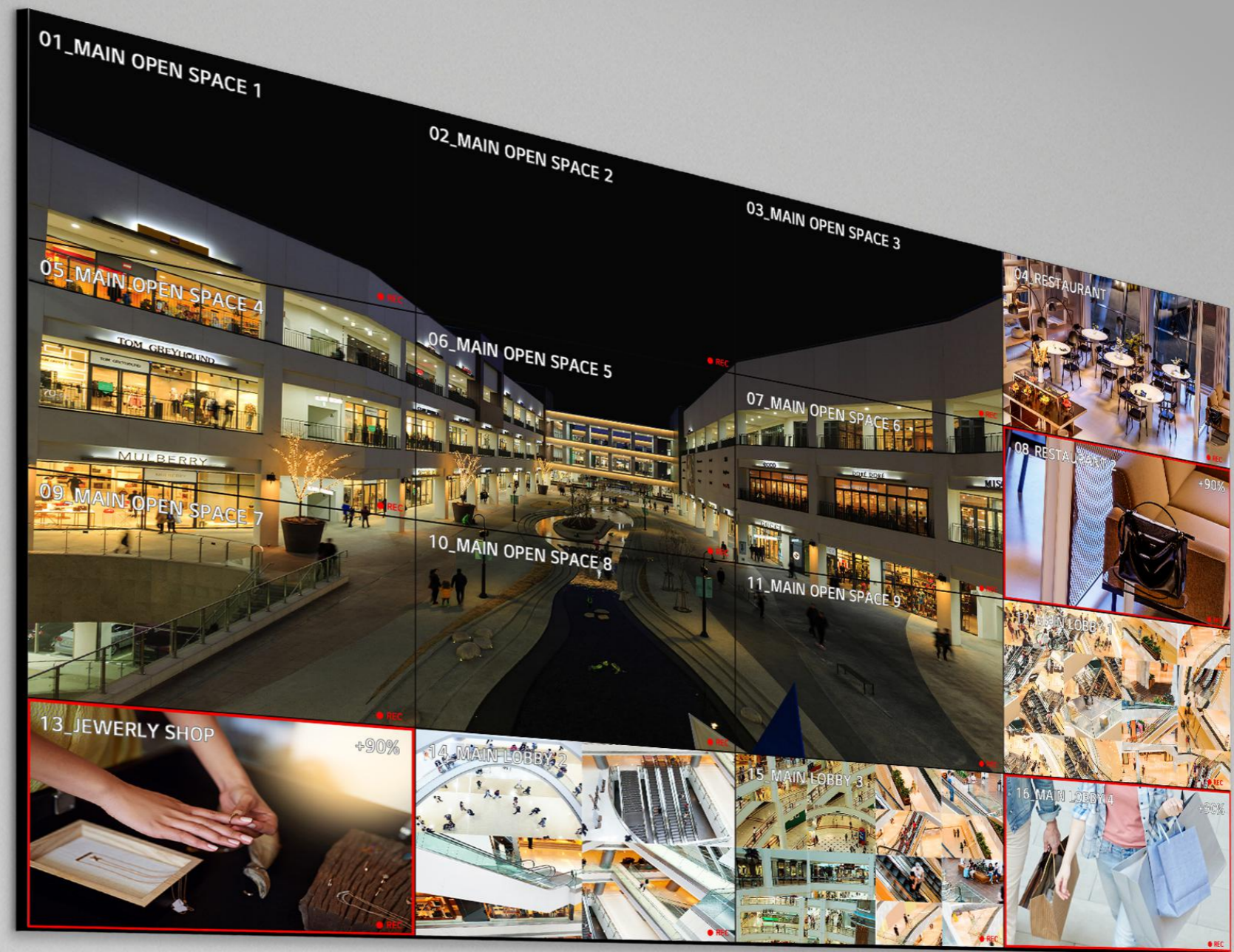

VIDEO WALL LINE UP

**Video Wall VL5PJ Series**

**VL5PJ** | 55" 49"



- Brightness(Typ.) : 500 nit
- Bezel : 2.25 mm (T/L), 1.25 mm (B/R)
- Depth : 93.1 mm
- Interface : HDMI/ DP/ DVI-D/ USB/ RS232C/ RJ45/ Audio/ IR

\* Based on 55VL5PJ Specification

**Video Wall VL5G-M Series**

**VL5G-M** | 49"



- Brightness(Typ.) : 500 cd/m<sup>2</sup>
- Bezel : 2.25 mm (T/L), 1.25 mm (B/R)
- Depth : 89.7 mm
- Interface : HDMI/ DP/ DVI-D/ USB/ RS232C/ RJ45/ Audio/ IR

\* Based on 49VL5G-M Specification

**Video Wall VH7J-H Series**

**VH7J-H** | 55"

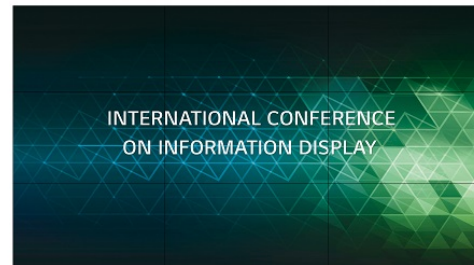

- Brightness(Typ.) : 700 nit
- Bezel : 1.74mm (Panel Bezel to Panel Bezel), 1.3mm (T/L), 0.44mm (B/R)
- Depth : 86.9 mm
- Interface : HDMI/ DP/ DVI-D/ USB/ RS232C/ RJ45/ Audio/ IR

\* Based on 55VH7J-H Specification

**Video Wall VSH7J Series**

**VSH7J** | 55"



- Brightness(Typ.) : 700 cd/m<sup>2</sup>
- Bezel : 0.44 mm (Even)
- Depth : 86.5 mm
- Interface : HDMI(2)/ DP/ DVI-D/ USB/ RS232C/ RJ45/ Audio/ IR
- Smart Calibration

\* Based on 55VSH7J Specification

**Video Wall VM5J-H Series**

**VM5J-H** | 55"



- Brightness(Typ.) : 500 nit
- Bezel : 1.74mm (Panel Bezel to Panel Bezel), 1.3mm (T/L), 0.44mm (B/R)
- Depth : 86.9 mm
- Interface : HDMI/ DP/ DVI-D/ USB/ RS232C/ RJ45/ Audio/ IR

\* Based on 55VM5J-H Specification

**Video Wall VSM5J Series**

**VSM5J** | 55"



- Brightness(Typ.) : 500 cd/m<sup>2</sup>
- Bezel : 0.44 mm (Even)
- Depth : 86.5 mm
- Interface : HDMI(2)/ DP/ DVI-D/ USB/ RS232C/ RJ45/ Audio/ IR
- Smart Calibration

\* Based on 55VSM5J Specification

## VIDEO WALL LINE UP

### Video Wall VL5F-A Series

**VL5F-A** | 55"

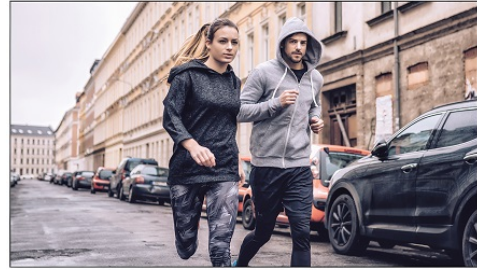

- Brightness(Typ.) : 500 cd/m<sup>2</sup>
- Bezel : 2.25 mm (T/L), 1.25 mm (B/R)
- Depth : 93.1 mm
- Interface : HDMI (2)/ DP/ DVI-D/ USB/ RS232C/ RJ45/ Audio/ IR

\* Based on 55VL5F-A Specification

# STRETCH

## Space Fitting Design for Effective Advertising

The unique bar-type displays are ideal for showing vertical or horizontal objects without truncation or compound content composed of video and text. Placed on pillars or any long structures, they provide an extraordinary viewing experience.



## STRETCH LINE UP

**Stretch BM5P Series****BM5P** | 105"

- Screen Size : 105"
- Resolution : 5,120 × 2,160 (5K)
- Brightness : 440 nit (Typ.), 385 nit (Min.)
- 21:9 Wide Screen
- Remote Device Management
- Wireless ScreenShare

\* Based on 105BM5P Specification

**Stretch BH7N Series****BH7N** | 37"

- Resolution : 1,920 × 540
- Brightness : 700 nit
- 32:9 Wide Screen
- Slim Design
- SuperSign CMS, SuperSign Control+, SuperSign WB, Mobile CMS, LG ConnectedCare
- webOS Solution

\* Based on 37BH7N Specification

**Stretch BH5F-M Series****BH5F-M** | 86"

- Brightness(Typ.) : 500 cd/m<sup>2</sup>
- Aspect Ratio: 58:9
- Bezel: 4.4 mm(L/R), 5.9 mm(T/B)
- Depth: 81.7mm
- Interface: HDMI (3), DP, USB(2), Audio, DVI-D, RS232C, RJ45, IR

\* Based on 86BH5F-M Specification

# UHD

## Absolute Color Vividness on Ultra HD Display

Vibrant colors and powerful performance bring content to life, effectively capturing the attention of passersby, driving traffic to the display's location.



| DEPARTURES       |         |        |      |         |
|------------------|---------|--------|------|---------|
| CITY             | TIME    | FLIGHT | GATE | REMARKS |
| Anchorage        | 8:00pm  |        | 50   | On Time |
| Austin           | 10:00pm |        | 56B  | On Time |
| Boston           | 11:40am |        | 57   | On Time |
| Chicago/O'Hare   | 10:15am |        | 53   | Now     |
| Chicago/O'Hare   | 11:50am |        | 58A  | Now     |
| Chicago/O'Hare   | 12:15pm |        | 56B  | On Time |
| Chicago/O'Hare   | 2:15pm  |        |      | On Time |
| Chicago/O'Hare   | 3:40pm  |        | 57   | On Time |
| Chicago/O'Hare   | 5:20pm  |        | 58B  | On Time |
| Chicago/O'Hare   | 9:50am  |        | 56B  | On Time |
| Chicago/O'Hare   | 11:40am |        | 58A  | On Time |
| Dallas/Ft. Worth | 12:50pm |        | 58B  | On Time |
| Dallas/Ft. Worth | 1:10pm  |        | 58A  | On Time |
| Dallas/Ft. Worth | 1:15pm  |        | 53   | On Time |
| Dallas/Ft. Worth | 2:35pm  |        |      | On Time |
| Dallas/Ft. Worth | 3:25pm  |        |      | On Time |
| Dallas/Ft. Worth | 4:35pm  |        |      | On Time |
| Dallas/Ft. Worth | 6:00pm  |        |      | On Time |
| Las Vegas        | 12:05pm |        |      | On Time |
| Las Vegas        | 1:35pm  |        |      | On Time |
| Las Vegas        | 2:40pm  |        |      | On Time |
| Las Vegas        | 4:55pm  |        |      | On Time |
| Las Vegas        | 6:10pm  |        |      | On Time |
| Las Vegas        | 8:05pm  |        |      | On Time |



UHD LINE UP

**Standard PK340S (NA) Series**

**PK340S (NA)** | 86" 75" 65" 55" 50" 43"

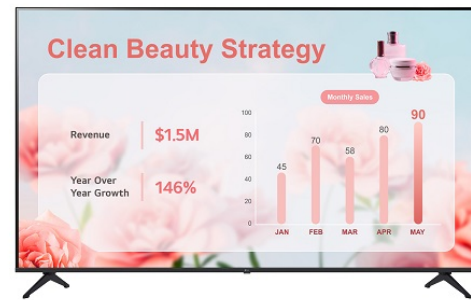

- Resolution : 3,840 × 2,160 (UHD)
- Brightness : 300 (Typ.) / 260 (Min.) nits
- Backlight Life : 30,000 Hrs, 16 Hrs / 7 Days
- LG Solution Compatibility

\* Based on 86PK340S (NA) Specification

**Standard PK640S (EU/CIS) Series**

**PK640S (EU/CIS)** | 86" 75" 65" 55" 50" 43"



- Resolution : 3,840 × 2,160 (UHD)
- Brightness : 300 nits
- Backlight Life : 30,000 Hrs, 16 Hrs / 7 Days
- LG Solution Compatibility

\* Based on 86PK640S (EU/CIS) Specification

**Standard PK340S (EU/CIS) Series**

**PK340S (EU/CIS)** | 86" 75" 65" 55" 50" 43"

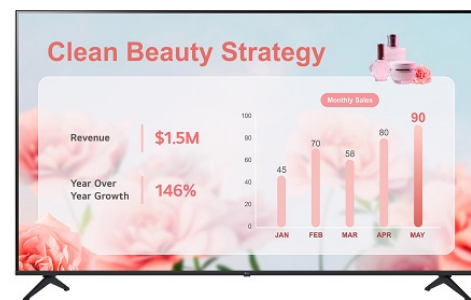

- Resolution : 3,840 × 2,160 (UHD)
- Brightness : 300 (Typ.) / 260 (Min.) nits
- Backlight Life : 30,000 Hrs, 16 Hrs / 7 Days
- LG Solution Compatibility

\* Based on 86PK340S (EU/CIS) Specification

**Standard PK640S (ASIA) Series**

**PK640S (ASIA)** | 86" 75" 65" 55" 50" 43"

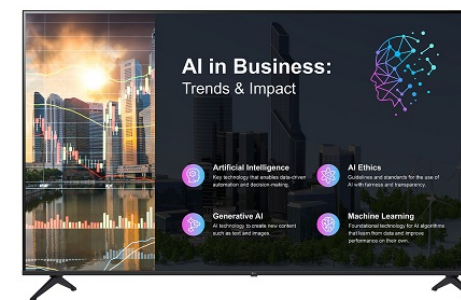

- Resolution : 3,840 × 2,160 (UHD)
- Brightness : 300 nits
- Backlight Life : 30,000 Hrs, 16 Hrs / 7 Days
- LG Solution Compatibility

\* Based on 86PK640S (ASIA) Specification

**Standard PK640S (NA) Series**

**PK640S** | 86" 75" 65" 55" 50" 43"



- Resolution : 3,840 × 2,160 (UHD)
- Brightness : 300 nits
- Backlight Life : 30,000 Hrs, 16 Hrs / 7 Days
- LG Solution Compatibility

\* Based on 86PK640S (NA) Specification

**Standard PK640S (SCA) Series**

**PK640S (SCA)** | 86" 75" 65" 55" 50" 43"



- Resolution : 3,840 × 2,160 (UHD)
- Brightness : 300 nits
- Backlight Life : 30,000 Hrs, 16 Hrs / 7 Days
- LG Solution Compatibility

\* Based on 86PK640S (SCA) Specification

UHD LINE UP

**Standard UL5Q-E Series**

**UL5Q-E** | 86" 75" 65" 55" 50" 43"



- Resolution : 3,840 × 2,160 (UHD)
- Brightness : 500 nit (Typ.)
- 24Hr Usage Scene (24 Hours / 7 Days)
- Even Bezel
- High-Performance with webOS 6.1

\* Based on 86UL5Q-E Specification

**Standard UP5Q-E Series**

**UP5Q-E** | 86" 75" 65" 55" 49" 43"



- Resolution : 3,840 × 2,160 (UHD)
- Brightness : 500 nits (Typ.)
- Bezel Width : 1.3.4 mm (Even)
- Surface Treatment (Haze) : 25%

\* Based on 86UP5Q-E Specification

**Standard UH5Q Series**

**UH5Q** | 65" 55" 49" 43"



- Resolution : 3,840 × 2,160 (UHD)
- Brightness : 500 nits (Typ.)
- Bezel Width : 11.4 mm (Even Bezel)
- webOS Smart Platform
- LG Shield

\* Based on 65UH5Q Specification

**Standard UV5N-E Series**

**UV5N-E** | 65" 55" 49"



- Resolution: 3,840 × 2,160 (UHD)
- Brightness: 500 nit (Typ.)
- 8.9 mm (T/R/L), 12.9 mm (B)
- BrightSignOS

\* Based on 65UV5N-E (NA) Specification

**Standard UL3Q-E Series**

**UL3Q-E** | 86" 75" 65" 55" 50" 43"



- Resolution : 3,840 × 2,160 (UHD)
- Brightness : 350 nit (Typ.)
- Face Up/Down with Tilt Support
- High-Performance with webOS 6.1
- Enhanced Security
- Sustainability for ESG

\* Based on 86UL3Q-E Specification

**Standard UH7N-M Series**

**UH7N-M** | 86" 75"

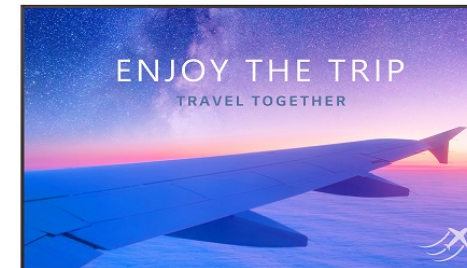

- Resolution : 3,840 × 2,160 (UHD)
- Brightness : 700 nits (Typ.)
- The product carbon footprint of this product has been verified by the Carbon Trust.
- Surface Treatment (Haze) : 25%

\* Based on 86UH7N-M Specification

UHD LINE UP

**Standard UH5N-M Series**

**UH5N-M** | 86" 75" 65" 55" 49" 43"



- Resolution : 3,840 × 2,160 (UHD)
- Brightness : 500 nits (Typ.)
- The product carbon footprint of this product has been verified by the Carbon Trust.
- Surface Treatment (Haze) : 25%
- Bezel Width : 13.4 mm

\* Based on 86UH5N-M Specification

**Standard US5P-E Series**

**US5P-E** | 65"

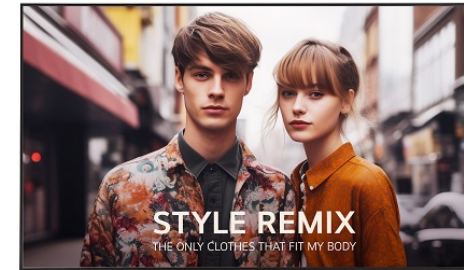

- Resolution : 3,840 × 2,160 (UHD)
- Brightness : 500 nit (Typ.)
- The carbon footprint of this product has been certified and achieved a reduction.
- Energy Efficiency
- Enhanced Security
- webOS Platform

\* Based on 65US5P-E Specification

**Standard UM340E (NA) Series**

**UM340E (NA)** | 75" 65" 55" 50" 43"



- Resolution : 3,840 × 2,160 (UHD)
- Brightness : 250 cd/m<sup>2</sup> (Center, Typ.)
- Surface Treatment (Haze) : 1%, 3 H
- Built-in Speakers : 10 W × 2

\* Based on 75UM340E (NA) Specification

**Standard UM5N-E Series**

**UM5N-E** | 65" 55" 49"

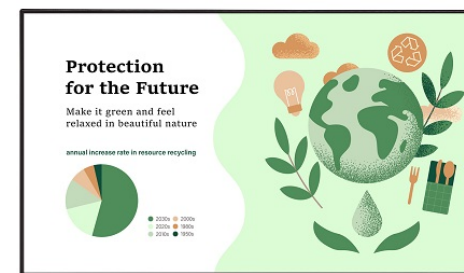

- Resolution : 3,840 × 2,160 (UHD)
- Brightness (Typ.) : 500 nit
- EPEAT (US Only)
- Bezel : 12.4 mm (T/R/L/B)
- Interface : HDMI(3) / DP / USB 2.0 / RS232C / RJ45 / Audio / IR

\* Based on 65UM5N-E Specification

**Standard UN340C (EU/CIS) Series**

**UN340C (EU/CIS)** | 43"



- Resolution : 3,840 × 2,160 (4K Ultra HD)
- Brightness : 300 nit
- webOS22
- Speaker : 20 W

\* Based on 43UN340C (EU/CIS) Specification

**Standard UH7N-E Series**

**UH7N-E** | 65" 55" 49"

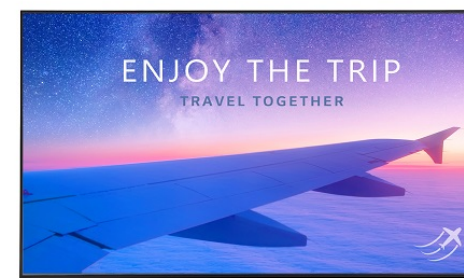

- Resolution : 3,840 × 2,160 (UHD)
- Brightness (Typ.) : 700 nit
- Bezel : 8.9 mm (T/R/L), 12.9 mm (B)
- Interface : HDMI(2) / DP / USB 2.0 / RS232C / RJ45 / Audio / IR
- webOS Smart Platform

\* Based on 65UH7N-E Specification

## UHD LINE UP

## Standard UM5N-H Series

UM5N-H | 65" 55" 49"



- Resolution : 3,840 x 2,160 (UHD)
- Brightness (Typ.) : 500 nit
- Bezel : 12.4 mm (T/R/L/B, Even)
- Interface : HDMI(3) / DP / USB 2.0 / RS232C / RJ45 / Audio / IR
- webOS Smart Platform

\* Based on 65UM5N-H Specification

## Standard ML5K Series

ML5K | 43" 32"



- Brightness : 500 nit (Typ.)
- Surface Treatment (Haze) : 25%
- Resolution : 3,840 x 2,160 (UHD)
- Bezel : 8.4 mm (T/R/L), 14.4 mm (B)
- Depth : 39.9 mm
- Interface : HDMI(3) / DP / DVI-D / USB 2.0 / RS232C / RJ45 / Audio / IR, etc.

\* Based on 43ML5K Specification

## Standard UR340C(NA) Series

UR340C | 86" 75" 65" 55" 50" 43"



- Brightness : 330 nits
- Resolution : 3,840 x 2,160 (UHD)
- Speaker (Sound Output) : 10 W + 10 W
- Operation Time : 16 Hours / 7 Days

\* Based on 86UR340C (NA) Specification

## Standard UM5K Series

UM5K | 98" 110"



- Brightness : 500 nit (Typ.)
- Resolution : ULTRA HD (3,840 x 2,160)
- Bezel : 17 mm (Even bezel)
- Built-in Speaker (10 W + 10 W)
- Interface : HDMI(3)/ DP/ DVI-D/ USB 2.0/ RS232C/ RJ45/ Audio/ IR

\* Based on 110UM5K Specification

## Standard UH5J-H Series

UH5J-H | 98" 43"

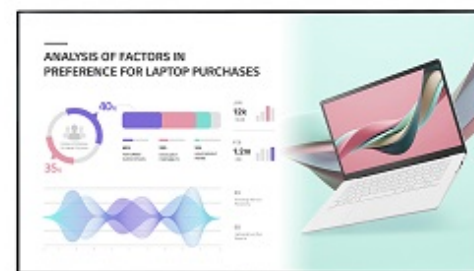

- Brightness(Typ.) : 500 cd/m<sup>2</sup>
- Surface Treatment (Haze) : 28%
- Bezel : 14.9 mm (Even bezel)
- Depth : 86.1 mm
- Interface : HDMI(3)/ DP/ DVI-D/ USB 2.0/ RS232C/ RJ45/ Audio/ IR
- Built-in Speaker

\* Based on 98UH5J-H Specification

## Standard UN640S (EU/CIS) Series

UN640S | 86" 75" 65" 55" 50" 43"



- Brightness(Typ.) : 330 nits
- Resolution : 4K Ultra HD (3,840 x 2,160)
- Improved Design with Slim Depth
- webOS-based High Performance
- Easy Content Management / Group Management
- SuperSign Control+ (Free version) / CMS Compatibility

\* Based on 86UN640S (EU/CIS) Specification

UHD LINE UP

**Standard UR640S(NA) Series**

**UR640S** | 86" 75" 65" 55" 50" 43"

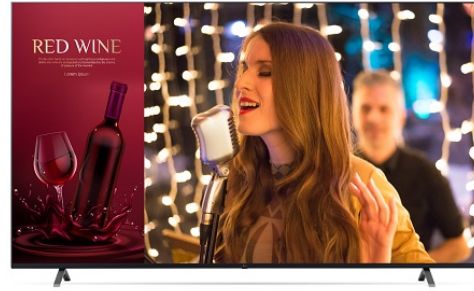

- Brightness(Typ.) : 330 nits
- Resolution : ULTRA HD (3,840 x 2,160)
- webOS-based High Performance
- Easy Content Management/Group Management
- SuperSign Control / CMS Compatibility

\* Based on 86UR640S (NA) Specification

**Standard UL3J-B Series**

**UL3J-B** | 86" 75" 65"



Compatible with **LG One:Quick** Share

- Brightness(Typ.) : 330 nits
- Resolution : ULTRA HD (3,840 x 2,160)
- webOS-based High Performance
- Built-in Speaker
- Compatible with LG's One:Quick Share
- Compatible with AV Control Systems

\* Based on 86UL3J-B Specification

**Standard UL3J-E Series**

**UL3J-E** | 75" 65"

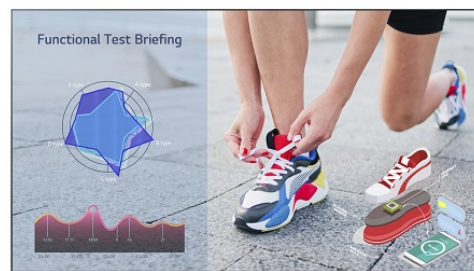

Compatible with **LG One:Quick** Share

- Brightness(Typ.) : 330 nits
- Resolution : ULTRA HD (3,840 x 2,160)
- EPEAT Registered
- webOS-based High Performance
- Compatible with LG's One:Quick Share
- Compatible with AV Control Systems

\* Based on 75UL3J-E Specification

# FHD

## A Broad Range of Offers for Diverse Customer Values

Easily installed in any venues, LG digital signage plays an integral role in customer engagement and spatial enhancement.



## FHD LINE UP

**Standard LN341C (EU) Series****LN341C (EU)** | 27"

- Resolution : 1,920 × 1,080 (Full HD)
- Brightness : 250 nit
- Speaker : 10 W

\* Based on 27LN341C (EU) Specification

**Standard SM3G-B Series****SM3G-B** | 22"

- Brightness(Typ.) : 250 cd/m<sup>2</sup>
- Bezel : 16.3mm
- Depth : 53.8mm
- Interface : HDMI(2) / USB 2.0 / RS232C / RJ45 / IR / Audio
- USB Plug & Play, Built-in Wi-Fi

\* Based on 22SM3G-B Specification

# SPECIAL

Experience Effective and Entertaining LG Special Signage

LG's Special allows you to experience effective and entertaining signages, designed to the particular requirements of a commercial environment. LG will revolutionize the way you conduct business.



SPECIAL LINE UP



**Self-Ordering LG Kiosk KC3P-MW**

**KC3P-MW** | 22"

- Modular Design
- Display Orientation
- Versatile Stand
- Serviceability
- Windows OS

\* Based on 22KC3P-MW Specification



**Self-Ordering LG Kiosk 27KC3P-M**

**KC3P-M** | 27"

- Modular Design
- Display Orientation
- Versatile Stand
- Serviceability
- Windows OS

\* Based on 27KC3P-M Specification



**Self-Ordering LG Kiosk 27KC3PK-C**

**KC3PK-C** | 27"

- 27-inch Display with an Excellent Touch Sensitivity
- Interior Fit Design
- Windows OS
- 27KC3K without Tactile Keypad

\* Based on 27KC3PK-C Specification

## LG webOS Smart Signage Platform

webOS is a web-based multipurpose platform in which a variety of web applications are deployed and implemented. It helps digital signage maximize interaction with customers by going beyond its conventional function of advertisement and information delivery, which ultimately serves as a partner to make your business thrive.



### Built-in Player

Powered by high-performance SoCs, it plays content with superb video graphic performance, without the need for a PC. Eliminating the need to purchase peripherals and extra cost for maintenance makes installation simpler and reduces the TCO.

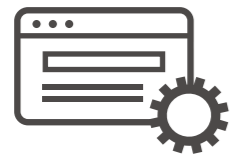

### Web-Centric

Using the most common web programming languages, including HTML, JavaScript, and CSS offers familiarity when creating and adapting your applications for the webOS platform.

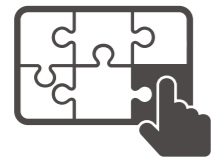

### Simple Customization

Free from any constraints, you can simply add interactive applications or external sensors to webOS signage for a higher level of customer engagement.



### Secured Communication

webOS ensures reliable communication between displays and web/data servers by supporting HTTPS and proxy servers.



### Content Management

webOS offers an embedded content management system equipped with an intuitive GUI, meaning that first-time users won't have to go through a complicated learning process to manage their displays.



### Monitoring and Control

Users can control and monitor the status of multiple displays in different locations in real-time, which is also available on internet-connected mobile devices, allowing you to rapidly respond to emergent situations.

## webOS Player

Even if you have an old version of webOS signage, you can make full use of the benefit of webOS platforms by purchasing only a webOS player. The LG webOS player, WP401 and WP402, upgrades your signage to webOS 4.0, allowing your old digital signage to perform its best.



### To Become a Partner

<http://webossignage.developer.lge.com/discover/our-partners>

LG is always on the success of our partners' business and keeps our minds open to achieve that success. The webOS Signage Developer Site is a significant part of this. Once you become authorized as a webOS partner, you can not only download the essential sources such as SDK, SCAP libraries, or sample applications, but also get answers and technical support from LG.

# LG SuperSign

## Software Solution

### SuperSign CMS

#### Versatile content management with enhanced usability

A variety of LG digital signage, whether stand-alone, outdoor, video walls, or LED signage, can be simultaneously connected and seamlessly managed by SuperSign CMS, with a single server. Administrators are free from the restraints of managing various display types and installation places, and they can operate an array of displays easily using a PC or mobile phone. Going a step further, SuperSign CMS offers OpenAPI, which allows system integrators to consolidate their solutions with SuperSign features and easily optimize them for LG digital signage, expanding the scope of its possible applications.

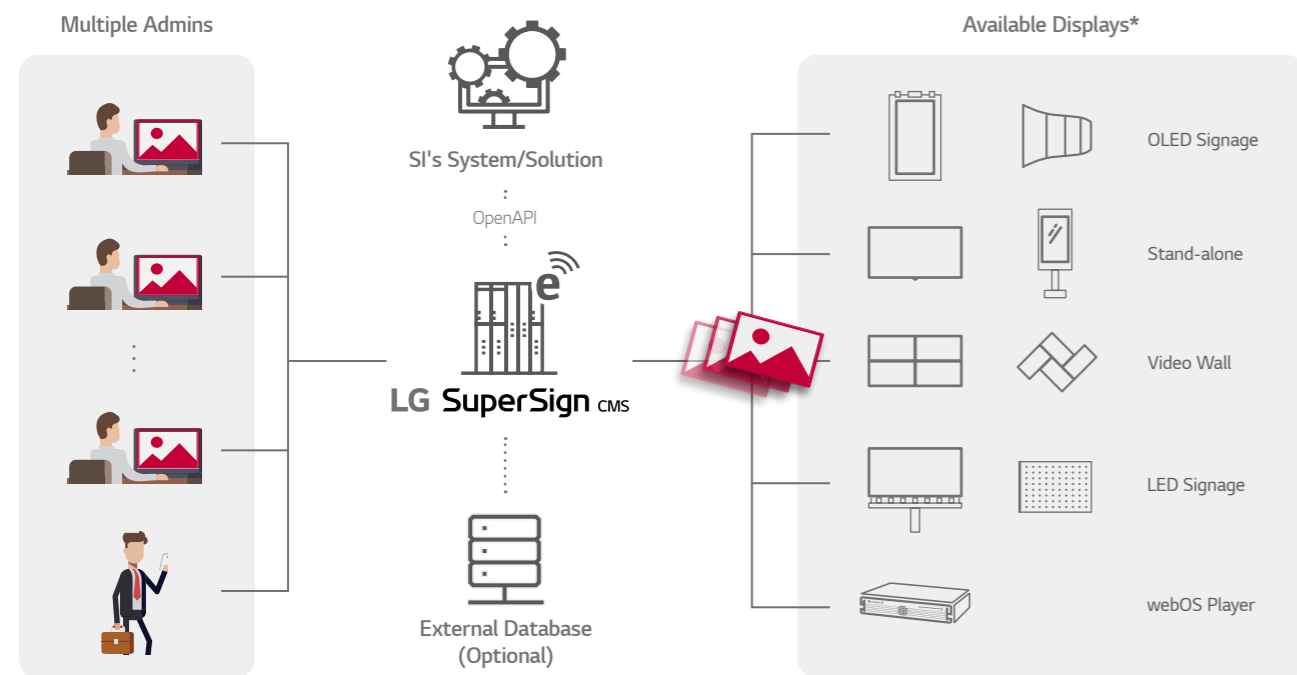

| No. of Displays     | ~ 50                                              | ~ 500                                                                           | ~ 1000                                                                          |
|---------------------|---------------------------------------------------|---------------------------------------------------------------------------------|---------------------------------------------------------------------------------|
| Server Construction | Single Server                                     | Single Server                                                                   | Single Server                                                                   |
| Recommended OS      | Windows 7, Windows 8.1, Windows 10                | Windows 7, Windows 8.1, Windows 10, Windows Server 2012 R2, Windows Server 2016 | Windows 7, Windows 8.1, Windows 10, Windows Server 2012 R2, Windows Server 2016 |
| CPU                 | Intel Core 2 Duo (2.5 GHz) or higher              | Intel i7 or higher                                                              | Intel XEON E5-2676 v3 8 Core or higher                                          |
| Memory              | 4 GB or more                                      | 4 GB or more                                                                    | 4 GB or more                                                                    |
| HDD                 | 40 GB or more of free space                       | 40 GB or more of free space                                                     | 40 GB or more of free space                                                     |
| Network Bandwidth   | 100 Mbps or higher                                | 100 Mbps or higher                                                              | 100 Mbps or higher                                                              |
| Browser             | Internet Explorer 10 or later, Chrome 50 or later | Internet Explorer 10 or later, Chrome 50 or later                               | Internet Explorer 10 or later, Chrome 50 or later                               |

\* Support may differ by model series.

### SuperSign Control+

#### Integrated Monitoring and Real-time Control

SuperSign Control+ is a remote control and monitoring software solution optimized for LG digital signage. It focuses on large scale deployment, supporting more than thousands of displays. Multiple accounts can access the SuperSign Control+ server via network to monitor the status of connected displays in real-time, control them, and adjust their setting values. As an ever-ready solution, it continuously monitors the status of displays and instantly sends out e-mail alerts to administrators when problems occur. Alerts and warnings can be customized according to various parameters such as power, fan and temperature as managers see fit.

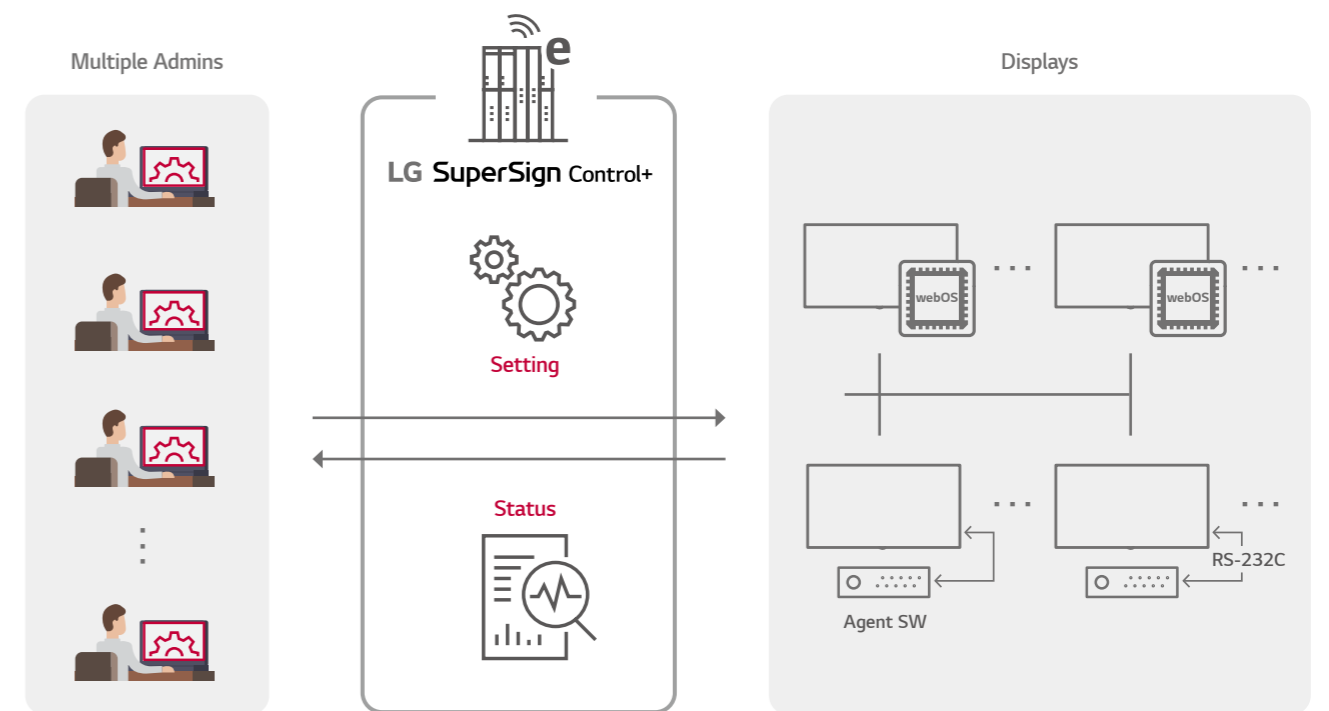

|                   | SuperSign Control+ Manager                                                                 | SuperSign Control+ Agent                      |
|-------------------|--------------------------------------------------------------------------------------------|-----------------------------------------------|
| Recommended OS    | Windows 7 64bit Platform, Windows 10 64bit Platform, Windows Server 2012 R2 64bit Platform | Windows 7, Windows 10, Windows Server 2012 R2 |
| CPU               | Intel XEON E5-2676 v3 8 Core or higher                                                     | Intel Core 2 Duo (2.5 GHz) or higher          |
| Memory            | 8 GB or more                                                                               | 4 GB or more                                  |
| HDD               | 40 GB or more of free space                                                                | 40 GB or more of free space                   |
| Network Bandwidth | 100 Mbps or higher                                                                         | 100 Mbps or higher                            |
| Browser           | Chrome 50 or later                                                                         | N/A                                           |

# LG SuperSign

## Software Solution

### SuperSign WB

#### Achieve Superb Color Consistency

Delivering stable and accurate color among connected displays is a key factor in determining the picture quality of a video wall. SuperSign WB adjusts the white balance to achieve this purpose by supporting camera and sensor calibration. Camera calibration lets users save time and manpower due to a simpler process than traditional sensor calibration, but it can recognize up to 3 x 3 layouts. So sensor calibration is recommended when a video wall layout has an irregular shape or is beyond 3 x 3 tiling.

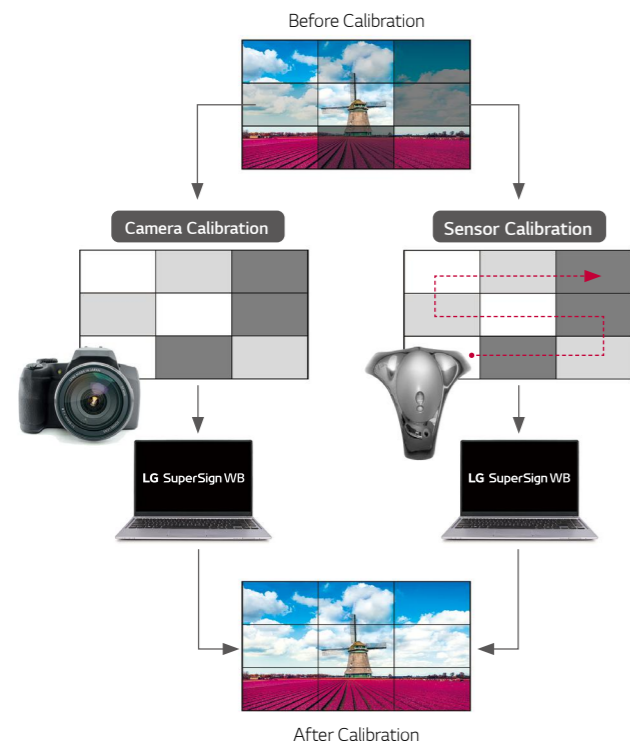

#### Camera Calibration

|        |                                                                                                          |
|--------|----------------------------------------------------------------------------------------------------------|
| Camera | DSLR Camera, Nikon D5300, D5500, D5600                                                                   |
| Lens   | AF-S DX NIKKOR 18-55 mm F3.5-5.6G VR II                                                                  |
| Tripod | Doesn't matter                                                                                           |
| USB    | One available Camera to PC (USB) connect cable<br>Recommended : USB extender cable 10M (32 feet)         |
| RS232  | One available RS232 to PC (USB) connect cable<br>Recommended : RS232 Serial extender cable 10M (32 feet) |

#### Sensor Calibration

|                  |                                                  |
|------------------|--------------------------------------------------|
| Supported Models | Spyder 3/4/5, i1 Display Pro, ACB8300, CA210/310 |
|------------------|--------------------------------------------------|

- Camera calibration is restricted to video wall models in configurations of up to 3 x 3.
- For optimal calibration results, your camera and video wall must each be facing the front center of the other.
- Install your camera in a horizontal orientation. Positioning your camera vertically may cause monitor detection to fail, which will lead to improper calibration.
- Only video walls configured in a square formation can be calibrated. Irregularly installed video walls are not supported.

### LG ConnectedCare

#### Real-time Monitoring and Fault Detection

LG ConnectedCare is a cloud service solution for remotely managing the operating status of signage displays installed in client workplaces. Through this service, causes of the fault can be easily identified prior to onsite visit, which leads to less time and cost for troubleshooting, ensuring the stable operation of a client's business.

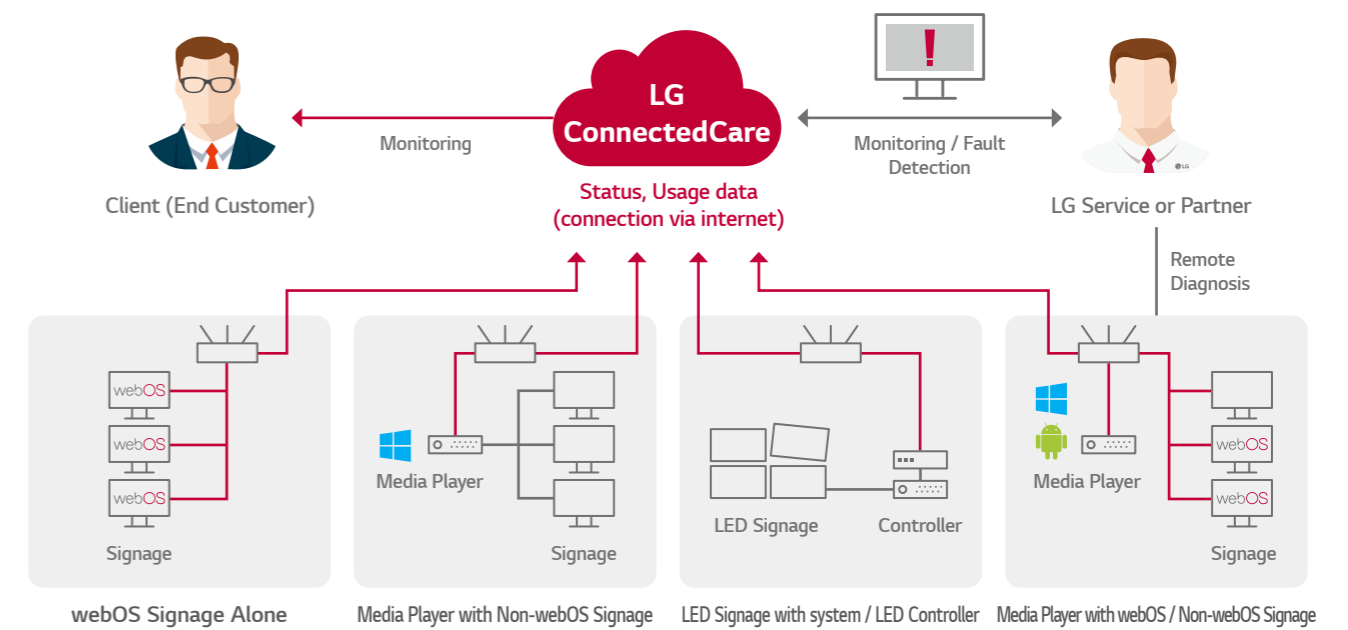

\* The versions of webOS and displays supported are currently being expanded. For further details, please contact LG sales in your region.

## LG ExtendedCare Service

### LG ExtendedCare

LG's true value begins after purchase. LG ExtendedCare plans offer you different levels of protection so that you can choose the perfect way to manage your digital signage.



### Longer Warranty Brings You Relief

As digital displays become more advanced prices also increase. LG's extended warranty helps maintain your important asset in its best condition.



### Problems Solved as Quickly as Possible

Our LG service team will reach you within Next Business Day depending on the coverage you select, thereby minimizing downtime and quickly getting things up and running again.



### Leave It Up to Our Experts

Authorized and experienced LG service technicians will provide repair and reinstallation services so that you don't have to lift a finger.

|                                            |                                   |                                  |
|--------------------------------------------|-----------------------------------|----------------------------------|
| <b>White Glove Service with Quick Swap</b> | <b>Quick Swap Service</b>         | <b>Extended Warranty Service</b> |
| <b>Next Business Day Exchange</b>          | <b>Next Business Day Exchange</b> | <b>Up to 5 years</b>             |

Authorized LG technicians will personally come to your location to exchange or deliver the product, providing an end-to-end service including deinstallation or reinstallation.

LG will ship replacement products for replacement directly to your location so that you can get your device up and running as soon as possible.

You can decide to add additional years to your existing warranty, to enjoy the fundamental care program provided by LG.



### Term Option

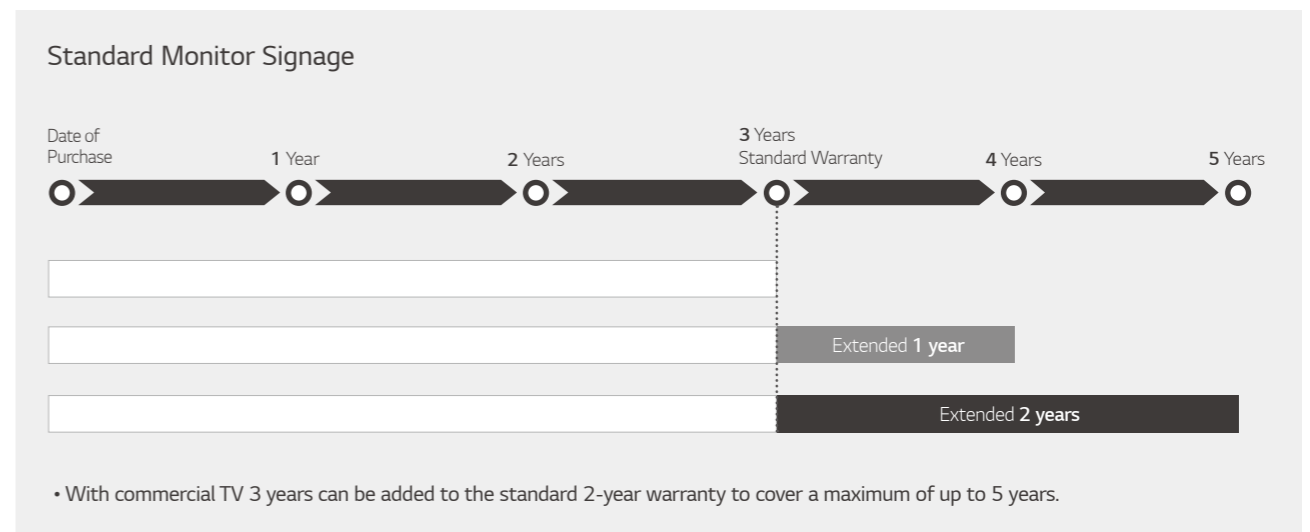

\* The information above is based on general standards. Please note that terms & conditions may vary from country to country.

\* Replacement products may be new, reconditioned, refurbished or otherwise factory remanufactured

\* The information above is based on general standards. Please note that terms & eligible products may vary from country to country.